

SpīNNaker

a universal
Spiking Neural Network
architecture

version 0.6 - DRAFT
4 December 2007

SpiNNaker - a chip multiprocessor for neural network simulation

Features

- 20 ARM968 processors, each with:
 - 64 Kbytes of tightly-coupled data memory;
 - 32 Kbytes of tightly-coupled instruction memory;
 - DMA controller;
 - communications controller;
 - vectored interrupt controller;
 - low-power ‘wait for interrupt’ mode.
- Multicast communications router
 - 6 serial inter-chip receive interfaces;
 - 6 serial inter-chip transmit interfaces;
 - 1024 associative routing entries.
- Interface to external SDRAM
 - over 1 Gbyte/s sustained block transfer rate.
- Ethernet interface for host connection
- Fault-tolerant architecture
 - defect detection, isolation, and function migration.
- Boot, test and debug interfaces (to be determined).

Introduction

SpiNNaker is a chip multiprocessor designed specifically for the real-time simulation of large-scale spiking neural networks. Each chip (along with its associated SDRAM chip) forms one node in a scalable parallel system, interconnected to the other nodes through self-timed links.

The processing power is provided through the multiple ARM cores on each chip. In the standard model, each ARM models multiple (up to 1,000) neurons, with each neuron being a coupled pair of differential equations modelled in continuous ‘real’ time. Neurons communicate through atomic ‘spike’ events, and these are communicated as discrete packets through the on- and inter-chip communications fabric. The packet contains a routing key that is defined at its source and is used to implement multicast routing through an associative router in each chip.

One processor on each SpiNNaker chip will perform system management functions; the communications fabric supports point-to-point packets to enable co-ordinated system management across local regions and across the entire system, and nearest-neighbour packets are used for system flood-fill boot operations and for chip debug.

Background

SpiNNaker was designed at the University of Manchester within an EPSRC-funded project in collaboration with the University of Southampton, ARM Limited and Silistix Limited. The work would not have been possible without EPSRC funding, and the support of the EPSRC and the industrial partners is gratefully acknowledged.

Intellectual Property rights

All rights to the SpiNNaker design are the property of the University of Manchester with the exception of those rights that accrue to the project partners in accordance with the contract terms.

Disclaimer

The details in this datasheet are presented in good faith but no liability can be accepted for errors or inaccuracies. The design of a complex chip multiprocessor is a research activity where there are many uncertainties to be faced, and there is no guarantee that a SpiNNaker system will perform in accordance with the specifications presented here.

The APT group in the School of Computer Science at the University of Manchester was responsible for all of the architectural and logic design of the SpiNNaker chip, with the exception of synthesizable components supplied by ARM Limited. All design verification was also carried out by the APT group. As such the industrial project partners bear no responsibility for the correct functioning of the device.

Change history

version	date	changes
0.0	27/12/05	First draft.
0.1	16/8/06	Sundry - document still developing.
0.2	18/11/06	Comms controller and NN protocol details modified.
0.3	19/02/07	Added ARM968 memory map, updated router pseudo-code, expanded system controller spec.
0.4	23/04/07	Added DMA controller, updated system controller to use ADK watchdog, updated comms controller.
0.5	05/11/07	Updated area estimates, added test chip details, added pin-out detail, added Ethernet MII interface, updated system diagrams.
0.6	04/12/07	Added details of timer/counter, vectored interrupt controller, PL340; removed Router implementation detail;

Contents

1. Chip organization	5
1.1 Block diagram	5
1.2 System-on-Chip hierarchy	5
2. System architecture	7
2.1 Routing	7
2.2 System-level address spaces	8
3. ARM968 processing subsystem	9
3.1 Features	9
3.2 ARM968 subsystem organisation	9
3.3 Memory Map	9
3.4 Fault-tolerance	10
3.5 Test	10
4. ARM 968	11
4.1 Features	11
4.2 Organization	11
4.3 Fault-tolerance	11
4.4 Test	11
5. Vectored interrupt controller	12
5.1 Features	12
5.2 Register summary	12
5.3 Register details	13
5.4 Interrupt sources	15
5.5 Fault-tolerance	16
5.6 Test	17
6. Counter/timer	18
6.1 Features	18
6.2 Register summary	18
6.3 Register details	19
6.4 Fault-tolerance	20
6.5 Test	21
7. DMA controller	22
7.1 Features	22
7.2 Using the DMA Controller	22
7.3 Register summary	23
7.4 Register details	24
7.5 Fault-tolerance	28
7.6 Test	28
8. Communications controller	29
8.1 Features	29
8.2 Packet formats	29
8.3 Control byte summary	30
8.4 Register summary	31
8.5 Register details	32
8.6 Fault-tolerance	34
8.7 Test	35
8.8 Notes	35

9. Communications NoC	36
9.1 Features	36
9.2 Block diagram	36
9.3 Arbiter structure	36
9.4 Fault-tolerance	37
9.5 Test	37
9.6 Notes	37
10. Communications Router	38
10.1 Features	38
10.2 Description	38
10.3 Internal organization	39
10.4 Multicast (MC) router	39
10.5 The point-to-point (p2p) router	40
10.6 The algorithmic (ALG) router	40
10.7 Time phase handling	40
10.8 Packet error handler	41
10.9 Emergency routing	41
10.10 Errant packets	41
10.11 Pseudo-code description	41
10.12 Registers	44
10.13 Fault-tolerance	44
10.14 Test	45
10.15 Notes	45
11. Inter-chip transmit and receive interfaces	46
11.1 Features	46
11.2 Programmer view	46
11.3 Fault-tolerance	46
11.4 Test	47
12. System NoC	48
12.1 Features	48
12.2 Fault-tolerance	48
12.3 Test	48
13. SDRAM interface	49
13.1 Features	49
13.2 Register summary	49
13.3 Register details	50
13.4 Fault-tolerance	57
13.5 Test	57
14. System Controller	58
14.1 Register summary	58
14.2 Register details	58
14.3 Fault-tolerance	59
14.4 Test	59
15. Router configuration registers	60
15.1 Features	60
15.2 Register summary	60
15.3 Register details	60
15.4 Fault tolerance	62
15.5 Test	62
15.6 Notes	62

16. Ethernet MII interface	63
16.1 Features	63
16.2 Using the Ethernet MII interface	63
16.3 Register summary	63
16.4 Register details	64
16.5 Fault-tolerance	68
16.6 Test	68
17. System RAM	69
17.1 Features	69
17.2 Address location	69
17.3 Fault-tolerance	69
17.4 Test	69
18. Boot ROM	71
18.1 Features	71
18.2 Address location	71
18.3 Fault-tolerance	71
18.4 Test	71
19. Boot, test and debug support	72
19.1 Features	72
19.2 Issues	72
19.3 Boot algorithm	72
19.4 Fault-tolerance	72
19.5 Test	72
20. Input and Output signals	73
20.1 External SDRAM interface	73
20.2 JTAG	73
20.3 Communication links	74
20.4 Ethernet MII	75
20.5 Miscellaneous	76
21. Area estimates	77
22. Power estimates	78
23. To Do.....	79

1. Chip organization

1.1 Block diagram

The primary functional components of SpiNNaker are illustrated in the figure below.

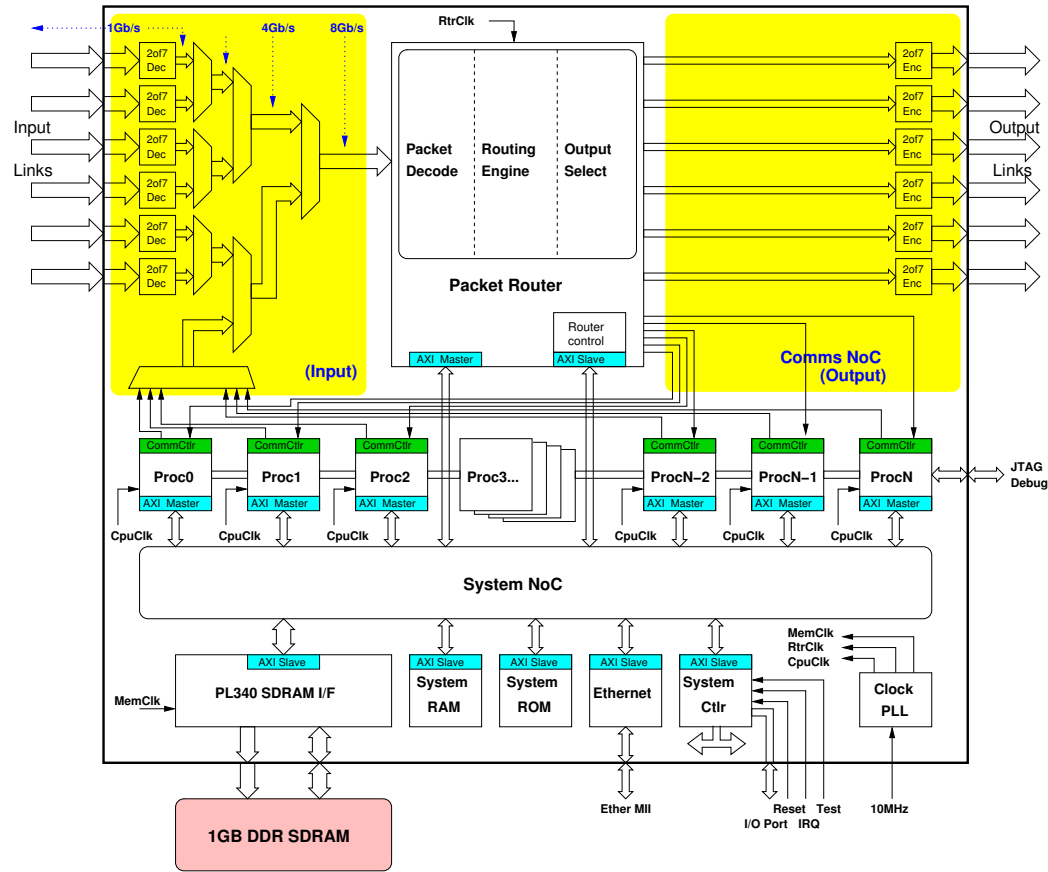

Each chip contains 20 identical processing subsystems. Following self-test, at start-up one of the processors is nominated as the Monitor Processor and thereafter performs system management tasks. Each of the remaining processors is responsible for modelling one or more neuron fascicles - a fascicle being a group of neurons with associated inputs and outputs (although some processors may be reserved as spares for fault-tolerance purposes).

The Router is responsible for routing neural event packets both between the on-chip processors and from and to other SpiNNaker chips. The Tx and Rx interface components are used to extend the on-chip communications NoC across to other SpiNNaker chips. The arbiter assembles inputs from the various on- and off-chip sources into a single serial stream which is then passed to the Router.

In addition to the primary function, there are additional resources accessible from the processor systems via the System NoC. Each of the processors has access to the shared off-chip SDRAM, and various system components also connect through the System NoC in order that, whichever processor is Monitor Processor, it will have access to these components.

The sharing of the SDRAM is an implementation convenience rather than a functional requirement, although it may facilitate function migration in support of fault-tolerant operation.

1.2 System-on-Chip hierarchy

The SpiNNaker chip is viewed as having the following structural hierarchy, which is reflected

throughout the organisation of this datasheet:

- ARM968 processor subsystem
 - the ARM968, with its tightly-coupled instruction and data memories
 - Timer/counter and interrupt controller
 - DMA controller / System NoC interface
 - communications controller, including communications NoC interface
- Communications NoC
 - Router, including multicast, algorithmic, nearest-neighbour, default and emergency routing functions
 - 6 inter-chip transmit interfaces
 - 6 inter-chip receive interfaces
 - communications NoC arbiter and fabric
- System NoC
 - SDRAM interface
 - System Controller
 - Router configuration registers
 - Ethernet MII interface
 - Boot ROM
 - System RAM
 - System NoC arbiter and fabric
- Boot, test and debug
 - central controller for ARM968 JTAG functions

2. System architecture

SpiNNaker is designed to form (with its associated SDRAM chip) a node of a massively parallel system. The system architecture is illustrated below:

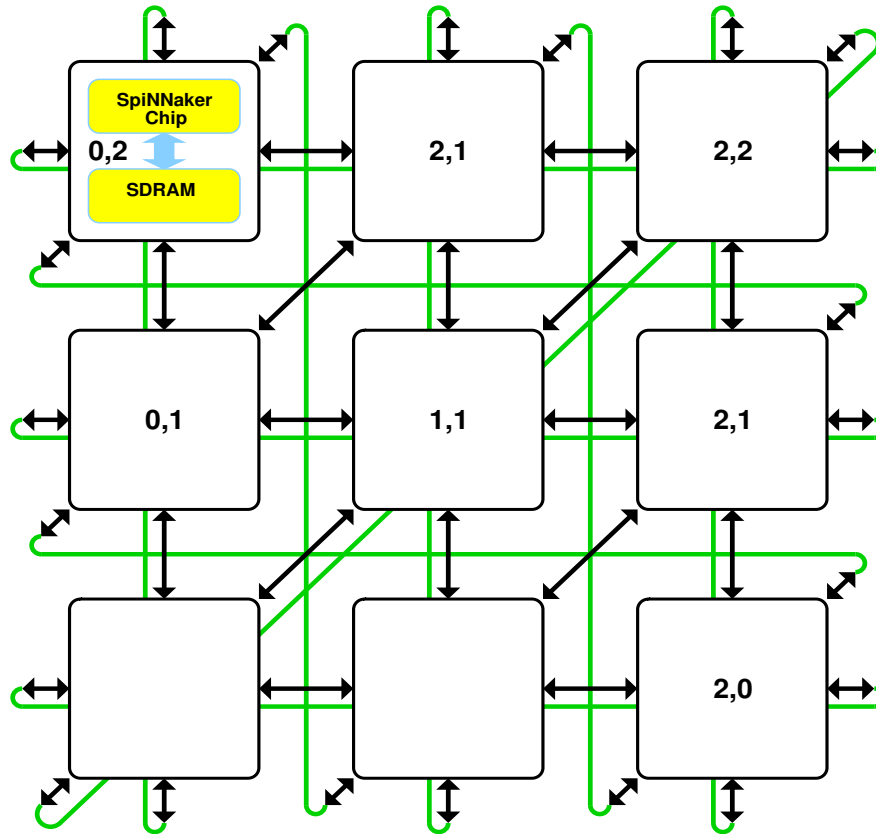

2.1 Routing

The nodes are arranged in a *hexagonal* mesh with bidirectional links to 6 neighbours. The system supports multicast packets (to carry neural event information, routed by the associative Multicast Router), point-to-point packets (to carry system management and control information, routed algorithmically) and nearest-neighbour packets (to support boot-time flood-fill and chip debug).

Emergency routing

In the event of a link failing or congesting, traffic that would normally use that link is redirected in hardware around two adjacent links that form a triangle with the failed link. This “emergency routing” is intended to be temporary, and the operating system will identify a more permanent resolution of the problem. The local Monitor Processor is informed of all uses of emergency routing.

Deadlock avoidance

The communications system has potential deadlock scenarios because of the possibility of circular dependencies between links. The policy used here to prevent deadlocks occurring is:

- *no Router can ever be prevented from issuing its output.*

The mechanisms used to ensure this are the following:

- outputs have sufficient buffering and capacity detection so that the Router knows whether or not an output has the capacity to accept a packet;

- emergency routing is used, where possible, to avoid overloading a blocked output;
- where emergency routing fails (because, for example, the alternative output is also blocked) the packet is ‘dropped’ to the local Monitor Processor;
- the local Monitor Processor is guaranteed to accept the dropped packet (eventually).

The expectation is that the communications fabric will be lightly-loaded so that blocked links are very rare. Where the operating system detects that this is not the case it will take measures to correct the problem by modifying routing tables or migrating functionality to a different part of the system.

Errant packet trap

Packets that get mis-routed could continue in the system for ever, following cyclic paths. To prevent this all packets are time stamped and a coarse global time phase signal is used to trap old packets. To minimize overhead the time stamp is 2 bits, cycling 00 -> 01 -> 11 -> 10, and when the packet is two time phases old (time sent XOR time now = 0b11) it is dropped to the local Monitor Processor and an error flagged. The length of a time phase can be adapted dynamically to the state of the system; normally timed-out packets should be very rare so the time phase can be conservatively long to minimise the risk of packets being dropped due to congestion.

2.2 System-level address spaces

The system incorporates a number of different levels of component that must be enumerated in some way:

- Each Node (where a Node is a SpiNNaker chip plus SDRAM) must have a unique, fixed address which is used as the destination ID for a point-to-point packet, and the addresses must be organised logically for algorithmic routing to function efficiently.
- Processors will be addressed relative to their host Node address, but this mapping will not be fixed as an individual Processor’s role can change over time. Point-to-point packets addressed to a Node will be delivered to the local Monitor Processor, whichever Processor is serving that function. Internal to a Node there will be some hard-wired addressing of each Processor for system diagnosis purposes, but this mapping will be hidden outside the Node.
- Neurons occupy an address space that identifies each Neuron uniquely within the domain of its multicast routing path (where this domain must include alternative links that may be taken during emergency routing). Where these domains do not overlap it is possible to reuse the same address, though this must be done with considerable care. Neuron addresses can be assigned arbitrarily, and this flexibility can be exploited to optimize Router utilization (for example by giving Neurons with the same routing requirements related addresses so that they can all be routed by the same Router entries).

3. ARM968 processing subsystem

SpiNNaker incorporates 20 ARM968 processing subsystems which provide the computational capability of the device. Each of these subsystems is capable of generating and processing neural events communicated via the Communications NoC and, alternatively, of fulfilling the role of Monitor Processor.

3.1 Features

- a synthesized ARM968 module with
 - a 200 MIPS ARM9 processor
 - 32 kB tightly-coupled instruction memory
 - 64 kB tightly-coupled data memory
- a local AHB with
 - communications controller connected to Communications NoC
 - DMA controller & interface to the System NoC
 - timer/counter and interrupt controller

3.2 ARM968 subsystem organisation

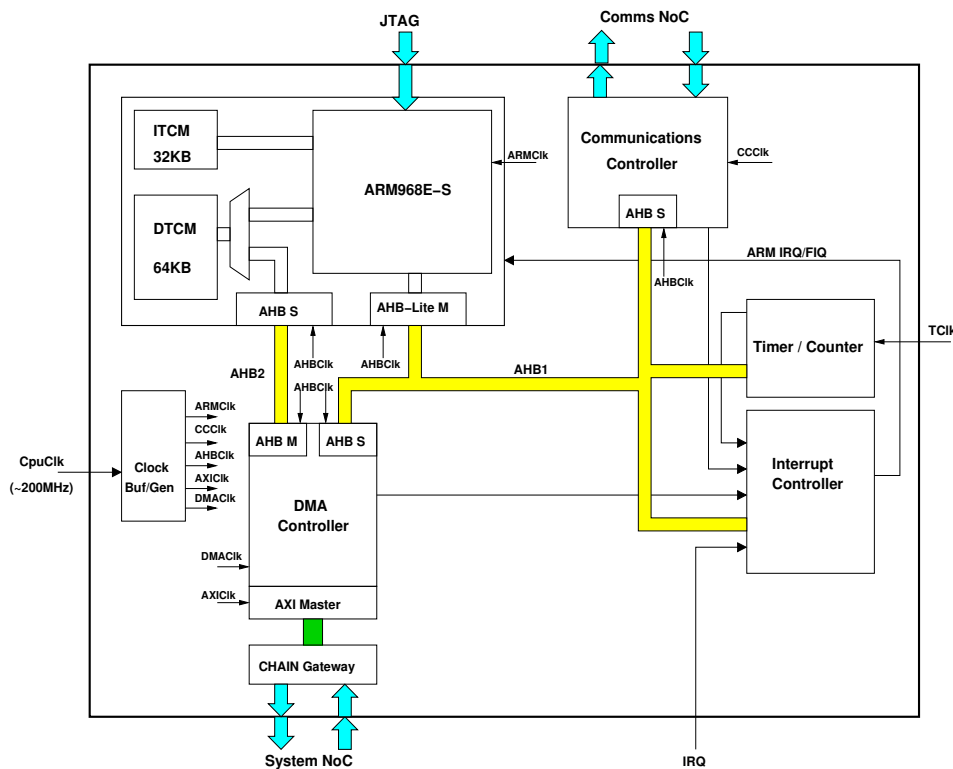

3.3 Memory Map

The memory map of the ARM968 spans a number of devices and buses. The tightly coupled memories are directly connected to the processor and accessible at the processor clock speed. All other parts of the memory map are visible via the AHB master interface. This gives direct access to the registers of the DMA controller, communications controller and the timer/interrupt controller. In addition, a path is available through the DMA controller onto the System NoC which provides

processor access to all memory resources on the System NoC. The memory map is defined as follows:

```
// Local to ARM968 nodes
#define ITCM_START_ADDRESS      0x00000000 // hard-wired in ARM968
#define DTCM_START_ADDRESS      0x00400000 // hard-wired in ARM968

// 8MB address area (NNOP) reserved for "operation mapping" in the NN protocol
// Can identify this area by top 9 bits=000011111
#define NNOP_START_ADDRESS      0x0f800000
#define NNOP_END_ADDRESS        0xffffffff

#define UNALLOC_SPACE_0_START   0x10000000 // address space not allocated
#define UNALLOC_SPACE_0_END     0xffffffff

// SDRAM
#define SDRAM_START_ADDRESS      0x20000000 // buffered write access
#define SDRAM_END_ADDRESS        0x2fffffff // buffered write access

#define SDRAM_UNBUF_START_ADDRESS 0x30000000 // unbuffered write access
#define SDRAM_UNBUF_END_ADDRESS  0x3fffffff // unbuffered write access

#define UNALLOC_SPACE_1_START   0x40000000 // address space not allocated
#define UNALLOC_SPACE_1_END     0xdfffffff

// Local peripherals - buffered write
#define COMM_CTL_START_ADDRESS   0xe0000000 // communications controller
#define DMA_CTL_START_ADDRESS    0xe1000000 // DMA controller
#define CTR_TIM_START_ADDRESS    0xe2000000 // counter-timer

// System NoC peripherals - buffered write
#define SDRAM_CONFIG              0xea000000 // PL340 configuration registers
#define ETH_CTL_START_ADDRESS     0xeb000000 // ethernet controller
#define RTR_CONFIG_START_ADDRESS  0xec000000 // router
#define SYS_CTL_START_ADDRESS     0xed000000 // system controller
#define SYS_RAM_START_ADDRESS     0xee000000 // system RAM
#define BOOT_ROM_START_ADDRESS    0xef000000 // system ROM
#define VIC_START_ADDRESS         0xffff0000 // vectored interrupt controller

// Local peripherals - unbuffered write
#define COMM_CTL_START_ADDRESS    0xf0000000 // communications controller
#define DMA_CTL_START_ADDRESS     0xf1000000 // DMA controller
#define CTR_TIM_START_ADDRESS     0xf2000000 // counter-timer

// System NoC peripherals - unbuffered write
#define SDRAM_CONFIG              0xfa000000 // PL340 configuration registers
#define ETH_CTL_START_ADDRESS     0xfb000000 // ethernet controller
#define RTR_CONFIG_START_ADDRESS  0xfc000000 // router
#define SYS_CTL_START_ADDRESS     0xfd000000 // system controller
#define SYS_RAM_START_ADDRESS     0xfe000000 // system RAM
#define BOOT_ROM_START_ADDRESS    0xff000000 // system ROM
#define HI_VECTORS                 0xffff0000 // high vector locations (boot)
#define VIC_START_ADDRESS         0xffff0000 // vectored interrupt controller
```

The ARM968 should be configured to use high vectors after reset (to use the vectors in ROM), but then switched to low vectors once the ITCM is enabled and initialised.

The vectored interrupt controller (VIC) has to be at 0xffff0000 to enable efficient access to its vector registers.

All other peripherals start at a base address that can be formed with a single MOV immediate instruction.

3.4 Fault-tolerance

The fault-tolerance of the ARM968 subsystem is defined in terms of its component parts, described below.

3.5 Test

The test strategies for the ARM968 subsystem are likewise defined in terms of its component parts.

4. ARM 968

The ARM968 (with its associated tightly-coupled instruction and data memories) forms the core processing resource in SpiNNaker. It is a standard synthesizable IP component from ARM Ltd, and as such there is limited scope for customizing it for this application.

4.1 Features

- 200 MIPS ARM9TDMI processor.
- 32 kB tightly-coupled instruction memory (I-RAM).
- 64 kB tightly-coupled data memory (D-RAM).
- AHB interface to external system.

4.2 Organization

See ARM DDI 0311C – the ARM968E-S datasheet.

4.3 Fault-tolerance

Fault insertion

- ARM9TDMI can be disabled.
- Software can corrupt I-RAM and D-RAM to model soft errors. (Can these be detected?)

Fault detection

- The I-RAM and D-RAM could be protected by parity bits (not implemented).
- A chip-wide watchdog timer catches runaway software.
- Self-test routines, run at start-up and during normal operation, can detect faults.

Fault isolation

- The ARM968 unit can be disabled from the System Controller.
- Defective locations in the I-RAM and D-RAM can be mapped out of use by software.

Reconfiguration

- Software will avoid using defective I-RAM and D-RAM locations.
- Functionality will migrate to an alternative Processor in the case of permanent faults that go beyond the failure of one or two memory locations.

4.4 Test

production test

start-up test

run-time test

5. Vectored interrupt controller

Each processor node on an SpiNNaker chip has a local vectored interrupt controller (VIC) that is used to enable and disable interrupts from various sources, and to wake the processor from sleep mode when required. The interrupt controller provides centralised management of IRQ and FIQ sources, and offers an efficient indication of the active sources for IRQ vectoring purposes.

The VIC is the ARM PL190, described in ARM DDI 0181E.

5.1 Features

- manages the various interrupt sources to each local processor
- individual interrupt enables
- routing to FIQ and/or IRQ (there will normally be only one FIQ source: CC Rx ready)
- a central interrupt status view
- a vector to the respective IRQ handler
- programmable IRQ priority
- interrupt sources:
 - Communication Controller flow-control interrupts
 - DMA complete/error/timeout
 - Timer 1 & 2 interrupts
 - interrupt from another processor on the chip (usually the Monitor processor), set via a register in the System Controller
 - packet-error interrupt from the Router
 - system fault interrupt
 - software interrupt, for downgrading FIQ to IRQ

5.2 Register summary

Base address: 0xefff000 (buffered write), 0xffff000 (unbuffered write).

User registers

The following registers allow normal user programming of the VIC:

Name	Offset	R/W	Function
r0: VICirqStatus	0x0	R	IRQ status register
r1: VICfiqStatus	0x4	R	FIQ status register
r2: VICrawInt	0x8	R	raw interrupt status register
r3: VICintSel	0xC	R/W	interrupt select register
r4: VICintEnable	0x10	R/W	interrupt enable register
r5: VICintEnClear	0x14	W	interrupt enable clear register
r6: VICsoftInt	0x18	R/W	soft interrupt register
r7: VICsoftIntClear	0x1C	W	soft interrupt clear register

Name	Offset	R/W	Function
r8: VICprotection	0x20	R/W	protection register
r9: VICvectAddr	0x30	R/W	vector address register
r10: VICdefVectAddr	0x34	R/W	default vector address register
VICvectAddr[15:0]	0x100-13c	R/W	vector address registers
VICvectCtrl[15:0]	0x200-23c	R/W	vector control registers

ID registers

In addition, there are test ID registers that will not normally be of interest to the programmer:

Name	Offset	R/W	Function
VICPeriphID0-3	0xFE0-C	R	Timer peripheral ID byte registers
VICPCID0-3	0xFF0-C	R	Timer Prime Cell ID byte registers

See the VIC Technical Reference Manual ARM DDI 0181E, for further details of the ID registers.

5.3 Register details

register 0: IRQ status

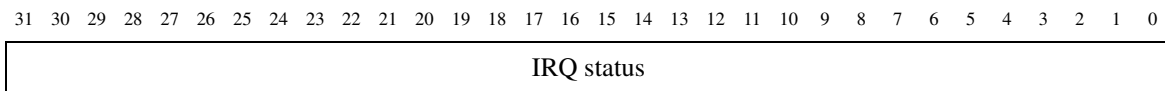

This read-only register yields the set of active IRQ requests (after masking).

register 1: FIQ status

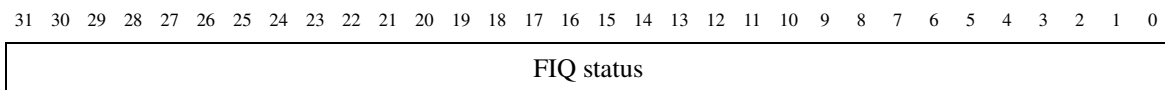

This read-only register yields the set of active FIQ requests (after masking).

register 2: raw interrupt status

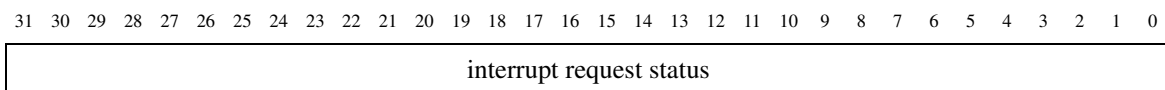

This read-only register yields the set of active input interrupt requests (before any masking).

register 3: interrupt select

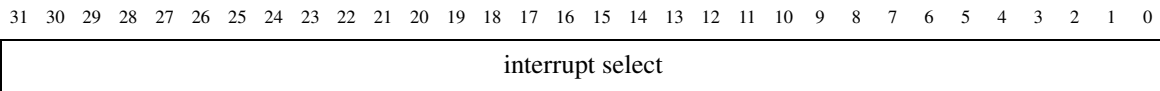

This register selects for each of the 32 interrupt inputs whether it gets sent to IRQ (0) or FIQ (1).

register 4: interrupt enable register

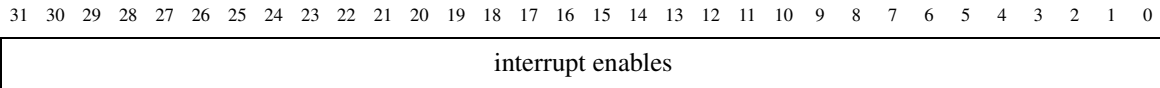

This register disables (0) or enables (1) each of the 32 interrupt inputs.

register 5: interrupt enable clear

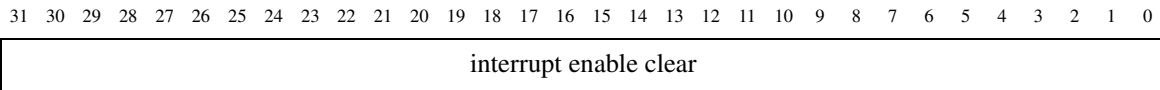

This write-only register selectively clears interrupt enable bits in r4. A '1' clears the corresponding bit in r4; a '0' has no effect.

register 6: soft interrupt register

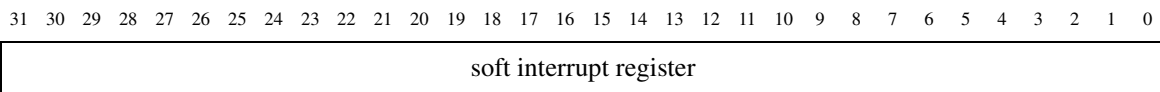

This register enables software to force interrupt inputs to appear high (before masking). A '1' written to any bit location will force the corresponding interrupt input to be active.

register 7: soft interrupt register clear

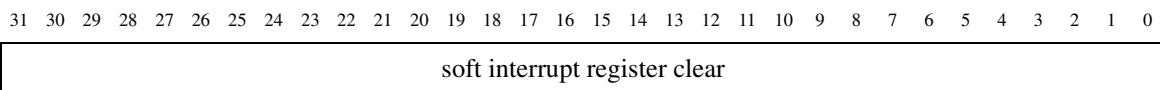

This write-only register selectively clears soft interrupt bits in r6. A '1' clears the corresponding bit in r6; a '0' has no effect.

register 8: protection

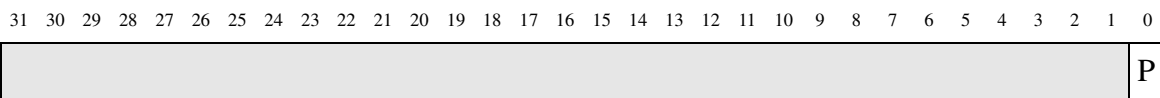

If the P bit is set VIC registers can only be accessed in a privileged mode; if it is clear then User-mode code can access the registers.

register 9: vector address

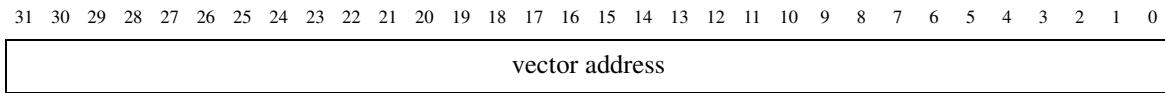

This register contains the address of the currently active interrupt service routine (ISR). It must be read at the start of the ISR, and written at the end of the ISR to signal that the priority logic should update to the next priority interrupt.

register 10: default vector address

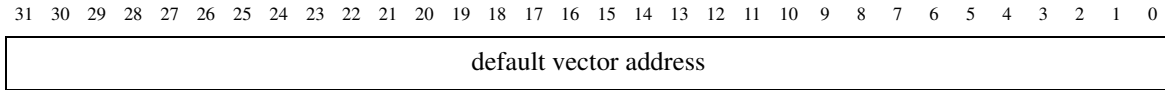

The default vector address is used by the 16 interrupts that are not vectored.

vector address [15:0]

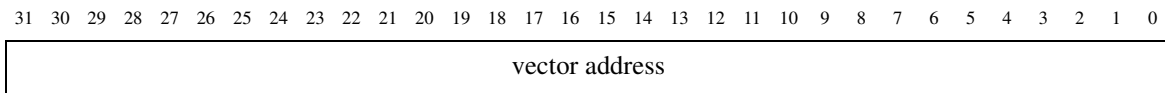

The vector address is the address of the ISR of the selected interrupt source.

vector control [15:0]

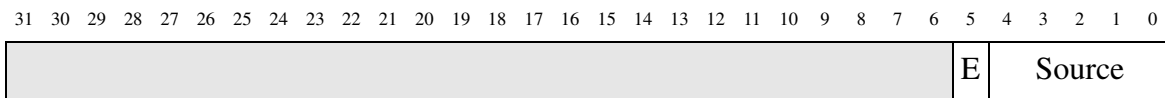

The interrupt source is selected by bits[4:0], which choose one of the 32 interrupt inputs. The interrupt can be enabled (E = 1) or disabled (E = 0).

The highest priority interrupt uses vector address [0] at offset 0x100 and vector control [0] at offset 0x200, and then successively reduced priority is given to vector addresses [1], [2], ... and vector controls [1], [2], ... at successively higher offset addresses.

5.4 Interrupt sources

14 of the 32 interrupt sources are local to the processor, 4 are from chip-wide sources (which will normally be enabled only in the Monitor Processor), and 14 are unused.

The interrupt sources are summarised in the table below:

#	Name	Function
0	Watchdog	Watchdog timer interrupt
1	software int	used only for local software interrupt generation
2	Comms Rx	the debug communications receiver interrupt
3	Comms Tx	the debug communications transmitter interrupt
4	Timer 1	Local counter/timer interrupt 1

#	Name	Function
5	Timer 2	Local counter/timer interrupt 2
6	CC Rx ready	Local comms controller packet received
7	CC Rx parity error	Local comms controller received packet parity error
8	CC Rx framing error	Local comms controller received packet framing error
9	CC Tx full	Local comms controller transmit buffer full
10	CC Tx overflow	Local comms controller transmit buffer overflow
11	CC Tx empty	Local comms controller transmit buffer empty
12	DMA done	Local DMA controller transfer complete
13	DMA error	Local DMA controller error
14	DMA timeout	Local DMA controller transfer timed out
15	Router error	Router error - packet parity, framing, or other error
16	Sys Ctl int	System Controller interrupt bit set for this processor
17	Ethernet Tx	Ethernet transmit frame interrupt
18	Ethernet Rx	Ethernet receive frame interrupt
19	Ethernet PHY	Ethernet PHY/external interrupt
20-31	not used	

5.5 Fault-tolerance

Fault insertion

It is fairly easy to mess up vector locations, and to fake interrupt sources.

Fault detection

A failed vector location effectively causes a jump to a random location; this would be messy!

Fault isolation

Failed vector locations can be removed from service.

Reconfiguration

A failed vector location can be removed from service (provided there are enough vector locations available without it). Alternatively, the entire vector system could be shut down and interrupts run by software inspection of the IRQ and FIQ status registers.

5.6 Test

production test

start-up test

run-time test

Most registers can be tested by read/write tests at any time.

6. Counter/timer

Each processor node on an SpiNNaker chip has a local counter/timer.

The counter/timers use the standard AMBA peripheral device described on page 4-24 of the AMBA Design Kit Technical Reference Manual ARM DDI 0243A, February 2003. The peripheral has been modified only in that the APB interface of the original has been replaced by an AHB interface for direct connection to the ARM968 AHB-Lite bus.

6.1 Features

- the counter/timer unit provides two independent counters, for example for:
 - millisecond interrupts for real-time dynamics
- free-running and periodic counting modes
 - automatic reload for precise periodic timing
 - one-shot and wrapping count modes
- 100 MHz counter clock may be pre-scaled by dividing by 1, 16 or 256

6.2 Register summary

Base address: 0xe2000000 (buffered write), 0xf2000000 (unbuffered write).

User registers

The following registers allow normal user programming of the counter/timers:

Name	Offset	R/W	Function
r0: Timer1load	0x0	R/W	Load value for Timer 1
r1: Timer1value	0x4	R	Current value of Timer 1
r2: Timer1Ctl	0x8	R/W	Timer 1 control
r3: Timer1IntClr	0xc	W	Timer 1 interrupt clear
r4: Timer1RIS	0x10	R	Timer 1 raw interrupt status
r5: Timer1MIS	0x14	R	Timer 1 masked interrupt status
r6: Timer1BGload	0x18	R/W	Background load value for Timer 1
r8: Timer2load	0x20	R/W	Load value for Timer 2
r9: Timer2value	0x24	R	Current value of Timer 2
r10: Timer2Ctl	0x28	R/W	Timer 2 control
r11: Timer2IntClr	0x2c	W	Timer 2 interrupt clear
r12: Timer2RIS	0x30	R	Timer 2 raw interrupt status
r13: Timer2MIS	0x34	R	Timer 2 masked interrupt status
r14: Timer2BGload	0x38	R/W	Background load value for Timer 2

Test and ID registers

In addition, there are test and ID registers that will not normally be of interest to the programmer:

Name	Offset	R/W	Function
TimerITCR	0xF00	R/W	Timer integration test control register
TimerITOP	0xF04	W	Timer integration test output set register
TimerPeriphID0-3	0xFE0-C	R	Timer peripheral ID byte registers
TimerPCID0-3	0xFF0-C	R	Timer Prime Cell ID byte registers

See AMBA Design Kit Technical Reference Manual ARM DDI 0243A, February 2003, for further details of the test and ID registers.

6.3 Register details

As both timers have the same register layout they can both be described as follows (X = 1 or 2):

register 0/8: Timer X load value

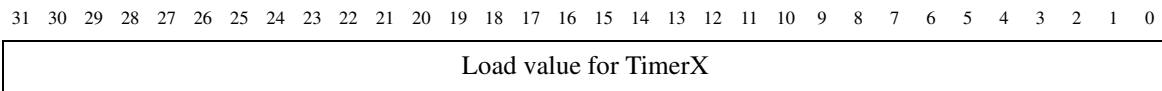

When written, the 32-bit value is loaded immediately into the counter, which then counts down from the loaded value. The background load value (r6/14) is an alternative view of this register which is loaded into the counter only when the counter next reaches zero.

register 1/9: Current value of Timer X

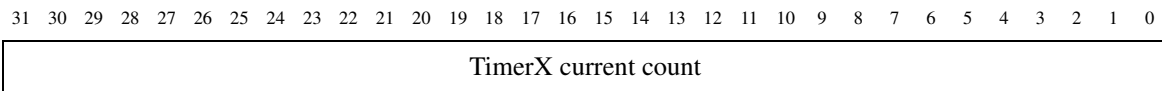

This read-only register yields the current count value for Timer X.

register 2/10: Timer X control

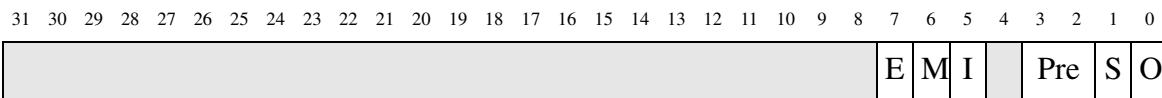

The shaded fields should be written as zero and are undefined on read. The functions of the remaining fields are described in the table below:

Name	bits	R/W	Function
E: Enable	7	R/W	enable counter/timer (1 = enabled)
M: Mode	6	R/W	0 = free-running; 1 = periodic
I: Int enable	5	R/W	enable interrupt (1 = enabled)
Pre: TimerPre	3:2	R/W	divide input clock by 1 (00), 16 (01), 256 (10)

Name	bits	R/W	Function
S: Timer size	1	R/W	0 = 16 bit, 1 = 32 bit
O: One shot	0	R/W	0 = wrapping mode, 1 = one shot

register 3/11: Timer X interrupt clear

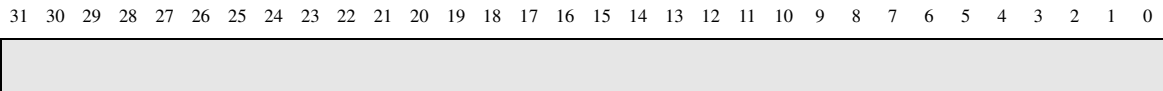

Any write to this address will clear the interrupt request.

register 4/12: Timer X raw interrupt status

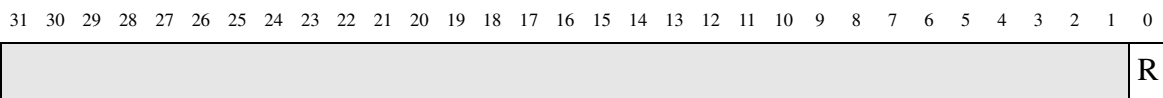

Bit zero yields the raw (unmasked) interrupt request status of this counter/timer.

register 5/13: Timer X masked interrupt status

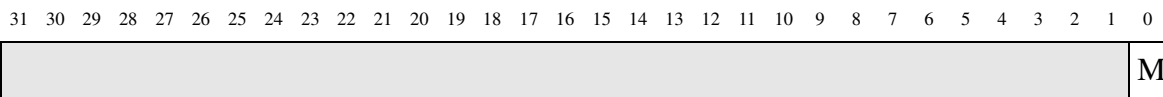

Bit zero yields the masked interrupt status of this counter/timer.

register 6/14: Timer X background load value

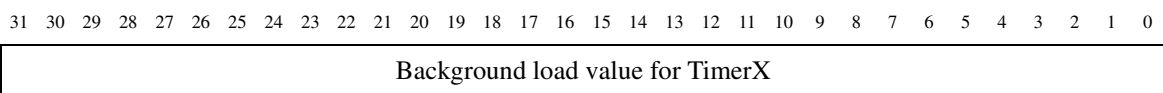

The 32-bit value written to this register will be loaded into the counter when it next counts down to zero. Reading this register will yield the same value as reading register 0/8.

6.4 Fault-tolerance

Fault insertion

Disabling a counter (by clearing the E bit in its control register) will cause it to fail in its function.

Fault detection

Use the second counter/timer with a longer period to check the calibration of the first?

Fault isolation

Disable the counter/timer with the E bit in the control register; disable its interrupt output; disable the interrupt in the interrupt controller.

Reconfiguration

If one counter fails then a system that requires only one counter can use the other one.

6.5 Test

production test

start-up test

run-time test

See 'fault detection' above.

7. DMA controller

Each ARM968 processing subsystem includes a DMA controller. The DMA controller is primarily used for transferring inter-neural connection data from the SDRAM in large blocks in response to an input event arriving at a fascicle processor, and for returning updated connection data during learning. In addition, the DMA controller provides access to other targets on the System NoC such as the System RAM and Router configuration target.

7.1 Features

- Multithreaded DMA engine supporting parallel operations
- Support for both DMA requests and direct pass-through CHAIN requests from ARM
- Dual buffers supporting simultaneous direct and DMA transfers
- Dual clock-domain FIFOs
- Support for error control in transferred blocks
- Interrupt-driven or polled DMA completion notification
- Parameterisable buffer size
- Direct and DMA request queueing
- Support for SDRAM address paging

7.2 Using the DMA Controller

There are 2 types of requests for DMA controller services. DMA requests use the full engine, are initiated by writing to control registers in the controller, execute in background, and issue an interrupt while complete - so that the ARM processor may set up a request and then return to other processing while the requests complete. Non-DMA requests go through the passthrough channel and are initiated by a request directly to the needed device or service. The DMA controller fulfills these requests transparently, the host processor retaining full control of the transfer. Invisible to the user, the controller may buffer the data from write requests for more efficient bus management. However, the ARM processor must control the entire data transfer throughout the process.

The controller is transparent to non-DMA requests, acting as a bridge between the AHB-Lite bus on the ARM port and the {AXI} bus on the Chain port. We will briefly outline the request latencies for various types of transfer on this bus. No operation will take less than 2 bus cycles, because of the 2 interfaces the request must pass through. Added to this 2 clock latency are the following additional clock cycles:

DMA controller register read or write	0
Buffered atomic data (ARM-Chain) write	0
Unbuffered atomic data write	1
Atomic data write, channel busy, buffer empty	1
Atomic data write, channel busy, buffer full, no DMA transfer	2
Atomic data write, channel busy, buffer full, DMA transfer in progress	indeterminate (min 2, max. burst_size +2)
Atomic data (ARM-Chain) read	1

Atomic data read, channel busy, no DMA transfer	indeterminate (min 2, max request_buffer_size +2)
Atomic data read, channel busy DMA transfer in progress	indeterminate (min 2, max burst_size+2)
Invalid request on the ARM (AHB slave) interface	0
Invalid request on the TCM(AHB master) interface:	1
Requests ending in an error on the Chain bus	2

Read requests while a DMA transfer is in progress require special handling. Such a request may have large latencies. Worst-case latency if the only outstanding request is the DMA transfer is the burst size plus 2 cycles. If, meanwhile, buffered write requests exist in the non-DMA queue, the read must wait until all these requests have completed (to ensure data coherency) before it can complete. The recommended procedure is for the ARM processor to interrogate the transfer_started bit in the DMA_Status register before requesting a non-DMA read.

To initiate a DMA transfer, the ARM must write to the following registers in the DMA controller: Control (CTRL), CHAIN Address (ADRC), TCM Address (ADRT), and Length (LEN). The processor may also optionally write the following register to set up specific transfer parameters: Interrupt Control (IRQC) Options (OPTS), and SDRAM Memory Segment Base Address (BASE). The processor may read from any register at any time. Once a transfer has started (as the transfer_started bit in the Status (STAT) register indicates), the processor may queue another request. The processor may have a maximum of 2 outstanding requests of which only one will be active. For the active request, the processor may only write to certain specific bits in the control and interrupt control register. An attempt to write any other register during an active transfer will result in an error. The controller does not clear the registers after a transfer so that the processor may, if desired, modify only those fields that change between transfers in order to initiate a new DMA transfer. Writing the Start bit in the control register commits the currently set up DMA request. There will be at minimum 4 clocks latency from the point when the Start bit is set to the point where the DMA transfer physically starts. Maximum latency occurs if there is a current non-DMA transfer in progress, in which case it could be as high as 20 (for a 16-word non-DMA burst started just as the Start bit was set). Data received on the source bus will appear on the destination bus 2 clock cycles later.

7.3 Register summary

Base address: 0xe1000000 (buffered write), 0xf1000000 (unbuffered write).

Name	Offset	R/W	Function
CHAIN Address (ADRC)	0x00	R/W	DMA address on the CHAIN bus
TCM Address (ADRT)	0x04	R/W	DMA address on the TCM interface
Length (LEN)	0x08	R/W	Length of the transfer in bytes
Control (CTRL)	0x0C	R/W	Control DMA transfer
Status (STAT)	0x10	R	Status of DMA and other transfers
Interrupt Control (IRQC)	0x14	W	Set interrupt configuration
Interrupt Status (IRQS)	0x18	R	Current interrupt status
Options (OPTS)	0x1C	R/W	Set less-frequently changed options

Name	Offset	R/W	Function
SDRAM Segment Base (BASE)	0x20	R/W	Fascicle page base address in SDRAM
Bytes Transferred	0x24	R*	No. of bytes transferred, current DMA
CHAIN Address 2 (AD2C)	0x100	R*	Double-buffered CHAIN bus address
TCM Address 2 (AD2T)	0x104	R*	Double-buffered TCM bus address
Length 2 (LN2)	0x108	R*	Double-buffered length
Control 2 (CTL2)	0x10C	R*	Double-buffered control
Options 2 (OPT2)	0x11C	R*	Double-buffered options

* These double-buffer registers are automatically written to if there is an active DMA transfer by writing to the addresses of their corresponding primary registers

7.4 Register details

Offset 0x00: CHAIN Address.

31 30 29 28 27 26 25 24 23 22 21 20 19 18 17 16 15 14 13 12 11 10 9 8 7 6 5 4 3 2 1 0

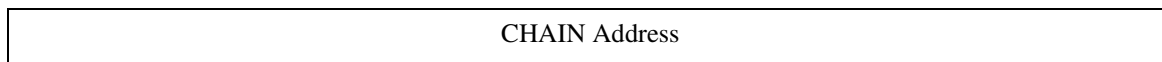

Bit 31:0 - Starting address on the CHAIN interface (AHB Master). Note that a read is considered a data movement from a source on the CHAIN bus to a destination on the TCM bus. If the `RELATIVE_ADDRESS` bit is set in the Options register, then this address is an offset into the SDRAM address whose base value is in `BASE`. This is useful if the ARM (probably acting as a fascicle processor) will be performing multiple transfers to the same area of SDRAM.

Offset 0x08 Length.

31 30 29 28 27 26 25 24 23 22 21 20 19 18 17 16 15 14 13 12 11 10 9 8 7 6 5 4 3 2 1 0



Bit 15:0 - Length of the DMA transfer. The TCM as currently envisioned has a maximum size of 64k (for the data TCM), thus, the length is a 16-bit register. A DMA transfer must of necessity either take as a source or a destination the TCM, justifying this restriction. See also the Request Size field in `CTRL`.

Offset 0x0C: Control Register

31 30 29 28 27 26 25 24 23 22 21 20 19 18 17 16 15 14 13 12 11 10 9 8 7 6 5 4 3 2 1 0

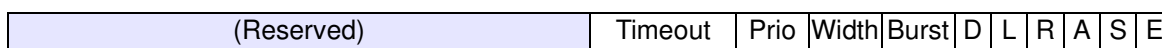

Bit 0 - 0 Enable. When set to 1 this enables the DMA interface. Pass-through functionality is always available.

Bit 1 - Start. Setting this bit starts a DMA transfer. The CPU should have written all necessary

control registers before this bit is set. Once set, the DMA transfer cannot be modified save by an abort, error, or restart command.

Bit 2 - Abort. End current transfer and clear the buffer. This command effectively wipes out the current transfer. The controller will wait for any pending bursts to complete but read data from such transactions will be discarded. This, the Enable bit, and the Restart bit, are the only bits of the control register the CPU can set when Start is 1.

Bit 3 - Restart. Resume a transfer that halted on an error or time-out. This is equivalent to setting the start bit with the transfer counter advanced to the position where the error occurred. Transfer will resume from that point. Note that the DMA does no checking to verify that any error-causing condition has been resolved: it is up to the CPU to correct the problem before resuming the transfer.

Bit 4 - Lock. Indicate to the DMA controller that it should initiate a locked transaction on the AHB Master interface. Normally this will be reserved for control-oriented transfers to the System RAM from the Monitor Processor, if at all.

Bit 5 - Direction. Indicate the direction of the transfer: 0 => read from SDRAM (CHAIN interface) 1 => write to SDRAM (CHAIN interface).

Bit 7:6 - Burst size in words. 00 = 1 word (single transfer) 01 = 4 words, 10 = 8 words, 11 = 16 words.

Bit 9:8 - Word width. 00 = 8-bit, 01 = 16-bit, 10 = 32-bit, 11 = 64-bit.

Bit 11:10 - Priority. Indicates how forcefully the DMA controller should request access to system resources.

00: No priority: the DMA controller accepts bus grants whenever they occur and does not schedule DMA transfers ahead of non-DMA transfers.

01: Low priority. The DMA controller indicates to the bus grant mechanism that it should favour this transaction over any pending 0-priority requests but otherwise does not reschedule requests.

10: Medium priority. The DMA controller does not place the transfer ahead of pending non-DMA transfers but any new non-DMA transfer will be queued behind it. It also requests the CHAIN arbiter to put this request ahead of all lower requests.

11: High priority. The controller schedules the request ahead of all pending transfers on its interface and requests the CHAIN arbiter to service it first.

Bit 15:12 - Timeout period (clocks) Specifies how long a pending transfer may wait for a bus response before timing out. Timeout period is $= 2^{(TO + 1)}$ clk.

Bit 31:16 - Request Size. Indicates the maximum size, in bytes that the DMA controller should treat as a single request. The controller will truncate longer requests and the second part will have to be resubmitted. This field is useful e.g. for protecting ITCM writes against wraparound that overwrites the bottom area of the ITCM (usually the boot area)

Offset 0x10: Status Register.

31	30	29	28	27	26	25	24	23	22	21	20	19	18	17	16	15	14	13	12	11	10	9	8	7	6	5	4	3	2	1	0
(Reserved)																Error code				Queue pos	A	T	W	S	C						

Bit 0 - Transfer Completed. Indicates that the current DMA transfer has finished and that the CPU may submit another. The CPU may need to examine the Error field for error messages.

Bit 1 - Transfer Started. Indicates that a transfer is underway. No DMA requests may be submitted. Non-DMA requests will be subject to wait states until the current transfer completes. As noted, the recommendation is that the CPU always interrogate this bit before a read operation.

Bit 2 - Waiting. Indicates a DMA transfer has been started - i.e. the Start bit in the Control Register has been set, but that the CHAIN arbiter has not yet granted access to the bus to the DMA controller.

Bit 3 - Timed out. Indicates the DMA controller timed out (after Timeout_period clocks) on a request.

Bit 4 - Token acquired. Indicates the DMA controller has been granted access to the CHAIN bus. If Transfer Started is not set then either the current transfer will begin immediately or will end immediately (This bit is mostly for internal use)

Bit 8:5 - Queue Position. Indicates where in the CHAIN request queue the current DMA request resides. The CPU can use this to estimate when the controller will be able to service its request.

Bit 19:9 - Error Code as follows

- 0x001 Illegal register modify attempt while transfer underway
- 0x002 Non-DMA buffer full
- 0x004 Non-DMA request buffer corrupted
- 0x008 Invalid address
- 0x010 Checksum Error

Offset 0x14 Interrupt Control.

31 30 29 28 27 26 25 24 23 22 21 20 19 18 17 16 15 14 13 12 11 10 9 8 7 6 5 4 3 2 1 0

(Reserved)																H	J	X	T	E	C
------------	--	--	--	--	--	--	--	--	--	--	--	--	--	--	--	---	---	---	---	---	---

Bit 0 - Enable Fast Interrupt on Completion. If this bit is set, the interrupt controller will signal the ARM via a Fast Interrupt that the data is ready for access.

Bit 1 - Enable Fast Interrupt on Error. If this bit is set, the interrupt controller will signal the ARM via a Fast Interrupt if an error occurs during a transfer (of any type)

Bit 2 - Enable Fast Interrupt on Timeout. If this bit is set, the interrupt controller will signal the ARM via a Fast Interrupt if a timeout occurs during an attempted transfer.

Bit 3 - Enable Interrupt on Completion. If this bit is set, the interrupt controller will signal the ARM via a Normal Interrupt that the data is ready for access.

Bit 4 - Enable Interrupt on Error. If this bit is set, the interrupt controller will signal the ARM via a Normal Interrupt if an error occurs during a transfer (of any type)

Bit 5 - Enable Interrupt on Timeout. If this bit is set, the interrupt controller will signal the ARM via a Normal Interrupt if a timeout occurs during an attempted transfer.

Offset 0x18 Interrupt Status.

31 30 29 28 27 26 25 24 23 22 21 20 19 18 17 16 15 14 13 12 11 10 9 8 7 6 5 4 3 2 1 0

(Reserved)																H	J	X	T	E	C
------------	--	--	--	--	--	--	--	--	--	--	--	--	--	--	--	---	---	---	---	---	---

Bit 0 - Fast Interrupt signalled on Completion. If this bit is set, a Fast Interrupt has been issued following successful completion of a DMA transfer. Setting the START bit in CTRL clears this value.

Bit 1 - Fast Interrupt signalled on Error. If this bit is set, an error occurred and the controller issued a Fast Interrupt to inform the ARM. Setting either the START or RESTART bits in CTRL clears

this value.

Bit 2 - Fast Interrupt signalled on Timeout. If this bit is set, a timeout occurred during an attempted transfer and the controller issued a Fast Interrupt to inform the ARM. Setting either the START or RESTART bits as above clears this value.

Bit 3 - Interrupt signalled on Completion. If this bit is set, an interrupt has been issued following successful completion of a DMA transfer. Setting the START bit in CTRL clears this value.

Bit 4 - Interrupt signalled on Error. If this bit is set, an error occurred and the controller issued an interrupt to inform the ARM. Setting either the START or RESTART bits as above clears this value.

Bit 5 - Interrupt signalled on Timeout. If this bit is set, a timeout occurred during an attempted transfer and the controller issued an interrupt to inform the ARM. Setting either the START or RESTART bits as above clears this value.

Offset 0x1C Options.

31	30	29	28	27	26	25	24	23	22	21	20	19	18	17	16	15	14	13	12	11	10	9	8	7	6	5	4	3	2	1	0
(Reserved)																								dis_b	err_d	R	D	P			

Bit 0 - PREFERRED_BUFFER Indicates which of the 2 buffers the controller should select for a DMA transfer if both buffers are available and DOUBLE_BUFFER is not set. Passthrough requests will use the other buffer.

Bit 1 - DOUBLE_BUFFER Setting this option doubles the size of the data FIFO buffer for a DMA transfer. If this bit is set, no other transfers may happen in background. Thus, with DOUBLE_BUFFER set all transfers on the DMA controller are blocking transfers with respect to the local ARM.

Bit 2 - RELATIVE_ADDRESS Instructs the DMA controller to use the address in BASE as a starting address to which ADRC is added as an offset, in order to calculate the starting address for the CHAIN side of the interface. Recommended only for fascicle processor SDRAM access.

Bit 4:3 - ERROR_DETECT[1:0] Enables detection of errors via checksum according to the following coding:

- 00 - no error detection
- 01 - generate checksums
- 10 - examine checksums
- 11 - both generate and examine checksums.

The controller evaluates the checksum at the end of a DMA transfer as the 2's complement sum of the data words in the transfer.

Bit 6:5 - DISABLE_BUFFER[1:0] This pair of bits disable each of the 2 buffers, the MSB disabling Buffer 1 and the LSB Buffer 0. If a buffer is disabled all requests will pass through the other buffer regardless of the setting of DOUBLE_BUFFER and PREFERRED_BUFFER. Disabling a buffer means that each access is blocking with respect to other requests. Disabling both buffers effectively pauses the DMA controller: the ARM can still issue new requests, but these will not be serviced until at least one buffer is enabled. The primary purpose of this field is for fault tolerance.

Offset 0x20 SDRAM Segment Base.

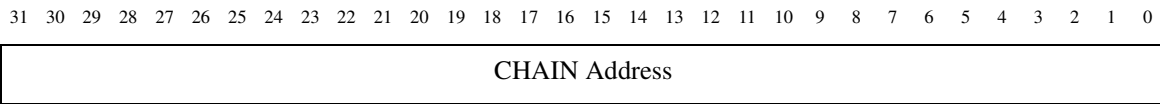

Bit 31:0 - Base address in memory of the SDRAM segment allocated to the local processor. This assumes a memory- management scheme where the Monitor processor allocates to each fascicle processor a private area of SDRAM for its own use. Using this value with relative addressing and request size constraints ensures that no fascicle processor can corrupt the other’s memory. This is useful for fault tolerance as well as performance because it can isolate faulty processors and prevent them from corrupting the whole SDRAM’s memory map.

Offset 0x24 Bytes Transferred

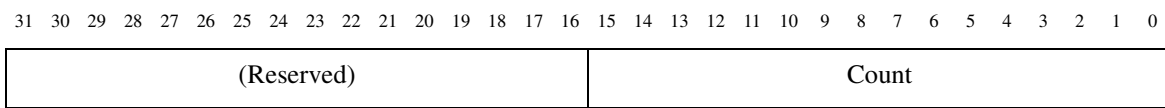

Bit 15:0 - Number of bytes transferred in the current DMA request. This register is the actual counter itself so that reading it will always give an accurate count of the progress of the DMA transfer.

7.5 Fault-tolerance

Fault insertion

Fault detection

Fault isolation

Reconfiguration

7.6 Test

production test

start-up test

run-time test

8. Communications controller

Each processor node on SpiNNaker includes a communications controller which is responsible for generating and receiving packets to and from the communications network.

8.1 Features

- Support for 3 packet types:
 - multicast neural event packets routed by a key provided at the source;
 - point-to-point packets routed algorithmically by destination address;
 - nearest-neighbour packets routed algorithmically by arrival port.
- Packets are either 40 or 72 bits long. The longer packets carry a 32-bit payload.
- 2-bit time stamp (used by Routers to trap errant packets).
- Parity (to detect corrupt packets).

8.2 Packet formats

Neural event multicast (mc) packets (type 0)

Neural event packets include a 32-bit routing key inserted by the source, and a control byte:

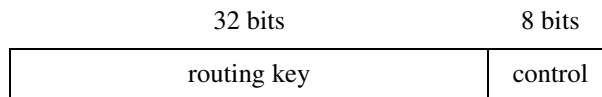

In addition they may include an optional (not normally used) 32-bit payload:

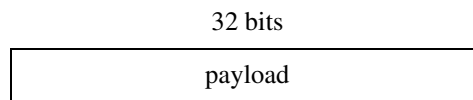

The 8-bit control field includes packet type (= 00 for multicast packets), emergency routing and time stamp information, a data payload indicator, and error detection (parity) information:

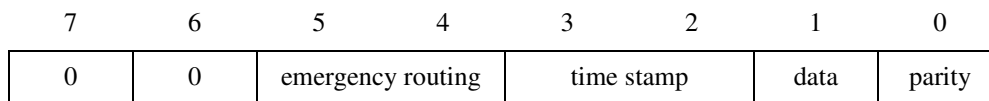

Point-to-point (p2p) packets (type 1)

Point-to-point packets include 16-bit source and destination chip IDs, plus a control byte and an optional (normally used) 32-bit payload:

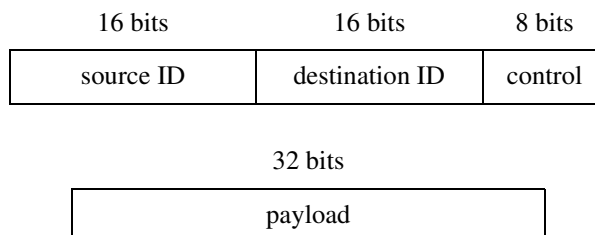

Here the 8-bit control field includes packet type (=01 for p2p packets), a sequence code, time

stamp, a data payload indicator and error detection (parity) information:

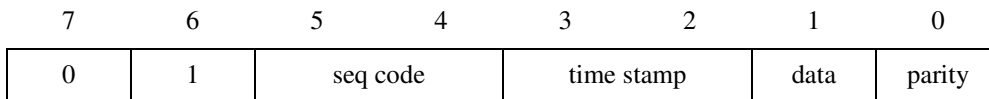

Nearest-neighbour (nn) packets (type 2)

Nearest-neighbour packets include a 32-bit address or operation field, plus a control byte and an optional 32-bit payload:

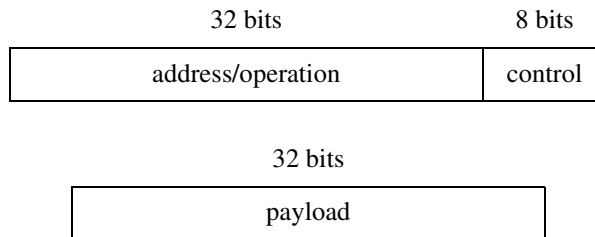

Here the 8-bit control field includes packet type (= 10 for nn packets), routing information, a data payload indicator and error detection (parity) information:

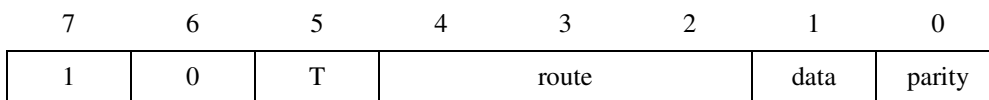

8.3 Control byte summary

Field Name	bits	Function
parity	0	parity of complete packet (including payload when used)
data	1	data payload (1) or no data payload (0)
time stamp	3:2	phase marker indicating time packet was launched
seq code	5:4	p2p only: start, middle odd/even, end of payload
emergency routing	5:4	mc only: used to control routing around a failed link
route	4:2	nn only: information for the Router
T: nn packet type	5	nn only: packet type - normal (0) or direct (1)
packet type	7:6	= 00 for mc; = 01 for p2p; = 10 for nn

parity

The complete packet (including the data payload where used) will have odd parity.

data

Indicates whether the packet has a 32-bit data payload (=1) or not (=0).

time stamp

The system has a global time phase that cycles through 00 -> 01 -> 11 -> 10 -> 00. Global

synchronisation must be accurate to within less than one time phase (the duration of which is programmable and may be dynamically variable). A packet is launched with a time stamp equal to the current time phase, and if a Router finds a packet that is two time phases old (time now XOR time launched = 11) it will drop it to the local Monitor Processor. The time stamp is inserted by the local Router, so the Communication Controller need do nothing here.

seq code

p2p packets use these bits to indicate the sequence of data payloads:

- 11 -> start packet: the first packet in a sequence (of >1 packets)
- 10 -> middle even: the second, fourth, sixth, ... packet in a sequence
- 01 -> middle odd: the third, fifth, seventh, ... packet in a sequence
- 00 -> end: the last (or only) packet in a sequence

emergency routing

mc packets use these bits to control emergency routing around a failed or congested link:

- 00 -> normal mc packet;
- 01 -> the packet has been redirected by the previous Router through an emergency route along with a normal copy of the packet. The receiving Router should treat this as a combined normal plus emergency packet.
- 10 -> the packet has been redirected by the previous Router through an emergency route which would not be used for a normal packet.
- 11 -> this emergency packet is reverting to its normal route.

route

These bits are set at packet launch to the values defined in the control register. They enable a packet to be directed to a particular neighbour (0 - 5), to all neighbours (6), or to the local Monitor Processor (7).

T (nn packet type)

This bit specifies whether an nn packet is 'normal', so that it is delivered to the Monitor Processor on the neighbouring chip(s), or 'direct', so that performs a read or write access to the neighbouring chip's System NoC resource.

packet type

These bits indicate whether the packet is a multicast (00), point-to-point (01) or nearest-neighbour (10) packet. Packet type 11 is reserved for future use.

8.4 Register summary

Base address: 0xe0000000 (buffered write), 0xf0000000 (unbuffered write).

Name	Offset	R/W	Function
r0: Tx control	0x0	R/W	Controls packet transmission
r1: Rx status	0x4	R/W	Indicates packet reception status
r2: send data	0x8	W	32-bit data for transmission
r3: send key	0xC	W	Send mc key/p2p dest ID & seq code

Name	Offset	R/W	Function
r4: receive data	0x10	R	32-bit received data
r5: receive key	0x14	R	Received mc key/p2p source ID & seq code
r6: reserved	0x18	-	-
r7: test	0x1C	R/W	Used for test purposes

A packet will contain data if r2 is written before r3; this can be performed using an ARM STM instruction.

8.5 Register details

r0: transmit control

31 30 29 28 27 26 25 24 23 22 21 20 19 18 17 16 15 14 13 12 11 10 9 8 7 6 5 4 3 2 1 0

E	F	O	U	Route	control byte	p2p source ID
---	---	---	---	-------	--------------	---------------

The functions of these fields are described in the table below:

Name	bits	R/W	Function
E: empty	31	R	Tx buffer empty
F: full	30	R/W	Tx buffer full (sticky)
O: overrun	29	R/W	Tx buffer overrun (sticky)
U: unused	28:27	-	-
Route	26:24	W	Set 'fake' route in packet
control byte	23:16	W	control byte of next sent packet
p2p source ID	15:0	W	16-bit chip source ID for p2p packets

The p2p source ID is expected to be configured once at start-up. The parity and sequence code fields of the control byte will be replaced by automatically-generated values when the packet is launched. The time stamp (where applicable) will be inserted by the local Router.

The transmit buffer full control is expected to be used, by polling or interrupt, to prevent buffer overrun. It is sticky, and once set will remain set until 0 is written to bit 30. Transmit buffer overrun indicates packet loss and will remain set until explicitly cleared by writing 0 to bit 29.

E, F and O reflect the levels on the Tx interrupt signals sent to the interrupt controller.

The route field allows a packet to be sent by a processor to the router which appears to have come from one of the external links. Normally this field will be set to 7 (0b111) but can be set to a link number in the range 0 to 5 to achieve this.

r1: receive status

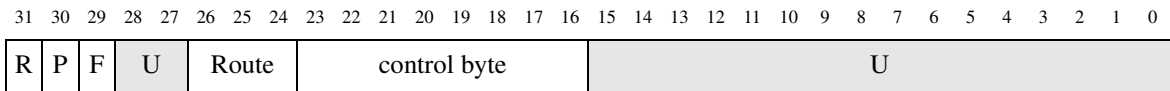

The functions of these fields are described in the table below:

Name	bits	R/W	Function
R: received	31	R	Rx packet received
P: parity	30	R/W	Rx packet parity error (sticky)
F: framing error	29	R/W	Rx packet framing error (sticky)
U: unused	28:27	-	-
Route	26:24	R	Rx route field from packet
Control byte	23:16	R	Control byte of last Rx packet
U: unused	15:0	-	-

A packet that is received without parity or framing error will set R, which will remain set until r5 has been read. A packet that is received with a parity and/or framing error sets P and/or F instead of R. These bits remain set until explicitly reset by writing 0 to bit 30 or bit 29 respectively.

R, P and F reflect the levels on the Rx interrupt signals sent to the interrupt controller.

r2: send data

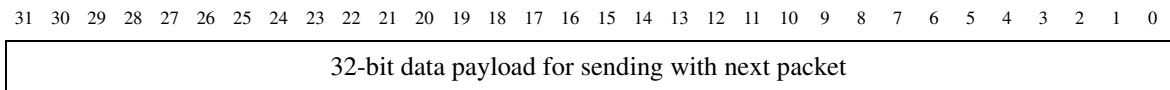

If data is written into r2 before a send key or dest ID is written into r3, the packet initiated by writing to r3 will include the contents of r2 as its data payload. If no data is written into r2 before a send key or dest ID is written into r3 the packet will carry no data payload.

r3: send mc key/p2p dest ID & sequence code

Writing to r3 will cause a packet to be issued (with a data payload if r2 was written previously).

If bits[23:22] of the control register are 00 the Communication Controller is set to send multicast packets and a 32-bit routing key should be written into r3. The 32-bit routing key is used by the associative multicast Routers to deliver the packet to the appropriate destination(s).

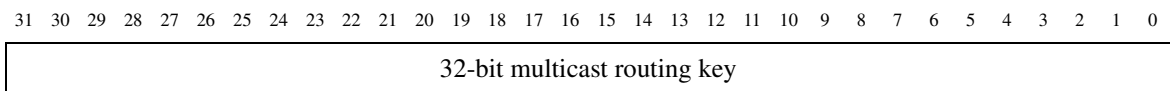

If bits[23:22] of the control register are 01 the Communication Controller is set to send point-to-point packets and the value written into r3 should include the 16-bit address of the destination chip in bits[15:0] and a sequence code in bits[17:16]. (See 'seq code' on page 31.)

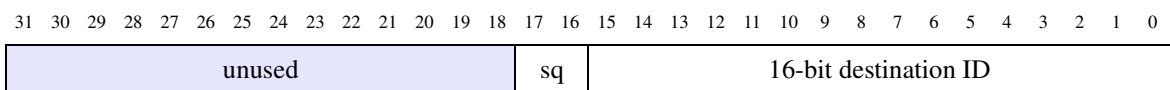

If bits[23:22] of the control register are 10 the Communication Controller is set to send nearest neighbour packets and the 32-bit nn address field should be written in r3.

r4: received data

31 30 29 28 27 26 25 24 23 22 21 20 19 18 17 16 15 14 13 12 11 10 9 8 7 6 5 4 3 2 1 0

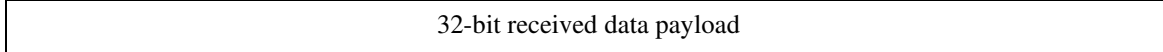

If a received packet carries a data payload the payload will be delivered here and will remain valid until r5 is read.

r5: received mc key/p2p source ID & sequence code

A received packet will deliver its mc routing key, nn address or p2p source ID and sequence code to r5. For an mc or nn packet this will be the exact value that the sender placed into its r3 for transmission; for a p2p packet the sequence number will be that placed by the sender into its r3, and the 16-bit source ID will be that in the sender's r0.

The register is read sensitive - once read it will change as soon as the next packet arrives.

r6: reserved

This register is reserved for future use.

r7: test

Setting bit 0 of this register makes all registers read/write for test purposes. Clearing bit 0 restricts write access to those register bits marked as read-only in this datasheet. All register bits may be read at any time.

8.6 Fault-tolerance

Fault insertion

Software can cause the Communications Controller to misbehave in several ways including inserting dodgy routing keys, source IDs, destination IDs.

Do we need to be able to force parity errors in transmit packets?

Fault detection

Parity of received packet; received packet framing error; transmit buffer overrun.

Fault isolation

The Communications Controller is mission-critical to the local processing subsystem, so if it fails the subsystem should be disabled and isolated.

Reconfiguration

The local processing subsystem is shut down and its functions migrated to another subsystem on this or another chip. It should be possible to recover all of the subsystem state and to migrate it, via the SDRAM, to a functional alternative.

8.7 Test

production test

start-up test

run-time test

8.8 Notes

- time phase accuracy: if we assume that the system time phase is F and the skew is K (that is, all parts of the system transition from one phase to its successor within a time K), then a packet has at least $F-K$ to reach its destination and will be killed after at most $2F+K$.
Thus, if we want to allow for a maximum packet transit time of $F-K = T$ and can achieve a minimum phase skew of K , then T and K are both system constants and we should choose $F = T+K$.
The longest packet life is then $2T+3K$.

9. Communications NoC

The communications NoC has the primary role of carrying neural event packets between fascicle processors on the same or different chips.

9.1 Features

- On- and inter-chip links
- Router which handles multicast, point-to-point and nearest neighbour packets.
- Arbiter to merge all sources into a sequential packet stream into the Router.
- Individual links can be reset to clear blockages and deadlocks.

9.2 Block diagram

A block diagram of the Communications NoC was given in section 1.1 on page 5.

9.3 Arbiter structure

As the input links converge on the Router they must merge through 2-way CHAIN arbiters, and the link width must increase to absorb the bandwidth. The following hierarchy is proposed:

- the local processor links can all be merged through a single-link arbiter tree as the local bandwidth is low, e.g. at most 20 processors x 1,000 neurons x 100Hz x 40 bits = 80 Mbit/s.
- the Rx interfaces can each carry up to 1 Gbit/s, about half the on-chip single-link bandwidth, so the first layer of arbiters can be single-link, the 2nd layer dual-link and the 3rd layer quad-link (i.e. 8-bits or 48 wires wide).
- buffering is required wherever the link width increases to ensure that the full arbiter bandwidth is used. Each buffer must be at least half a packet long - 36 bits?
- at each arbiter merging Rx interfaces the packet must pick up 1 bit to indicate its source, for default routing [unless the source tagging is done by the Rx interface?]

The Arbiter structure is illustrated below. Each doubling of the wires represents a doubling of the CHAIN link width. The numbers indicate source tagging of the packets.

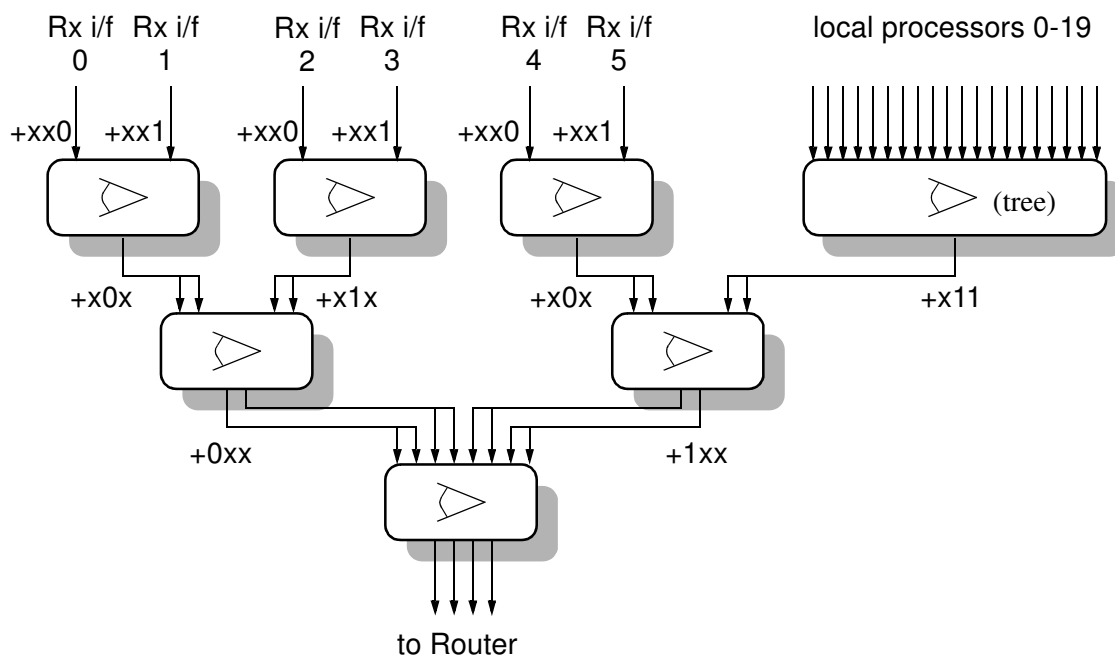

9.4 Fault-tolerance

Fault insertion

There is little direct control of the Communications NoC fabric except at the periphery as noted in the sections below.

Fault detection

Most failures will cause local asynchronous deadlock, which is readily detected at both the transmitting and receiving ends of the link.

Fault isolation

If links fail their clients will have to be disabled and their functions migrated.

Reconfiguration

Client functional migration is required.

9.5 Test

production test

start-up test

run-time test

9.6 Notes

- must decide whether to add source tags for default routing in arbiters or in Rx interfaces.

10. Communications Router

The Communications Router is responsible for routing all packets that arrive at its input to one or more of its outputs. Its primary function is to route multicast neural event packets, which it does through an associative multicast router subsystem. But it is also responsible for routing point-to-point packets (for which it uses a look-up table), for nearest-neighbour routing (which is a simple algorithmic process), for default routing (when a multicast packet does not match any entry in the multicast router) and for emergency routing (when an output link is blocked due to congestion or hardware failure).

Various error conditions are identified and handled by the Communications Router, for example packet parity errors, time-out, and output link failure.

10.1 Features

- 1024 programmable associative multicast routing entries.
 - associative routing based on source ‘key’.
 - with flexible ‘don’t care’ masking.
 - updatable ‘on the fly’.
- look-up table routing of point-to-point packets
- algorithmic routing of nearest-neighbour packets.
- support for 40- and 72-bit multicast, point-to-point and nearest neighbour packets.
- default routing of unmatched multicast packets.
- automatic ‘emergency’ re-routing around failed links.
 - programmable wait time before emergency routing and before dropping packet
- pipelined implementation to route 1 packet per cycle (peak)
 - back-pressure flow control
 - power-saving pipeline control
- failure detection and handling:
 - packet parity error
 - time-expired packet
 - output link failure
 - corrupt (wrong length) packet

10.2 Description

We assume that packets arrive from other nodes via the link receiver interfaces and from internal clients and are presented to the router one-at-a-time. The Arbiter is responsible for determining the order of presentation of the packets, but as each packet is handled independently the order is unimportant (though it is desirable for packets following the same route to stay in order).

Each packet contains an identifier that is used by the Communications Router to determine which of the outputs the packet is sent to. These outputs may include any subset of the output links, where the packet may be sent via the respective link transmitter interface, and/or any subset of the internal processor nodes, where the packet is sent to the respective Communications Controller.

For the neural network application the identifier can be simply a number that uniquely identifies the source of the packet – the neuron that generated the packet by firing. This is ‘source address routing’. In this case the packet need contain only this identifier, as a neural spike is an ‘event’ where the only information is that the neuron has fired.

The Router then functions simply as a look-up table where for each identifier it looks up a routing word, where each routing word contains 1 bit for each destination (each link transmitter interface and each local processor) to indicate whether or not the message should be passed to that destination.

10.3 Internal organization

The internal organization of the Communications Router is illustrated in the figure opposite.

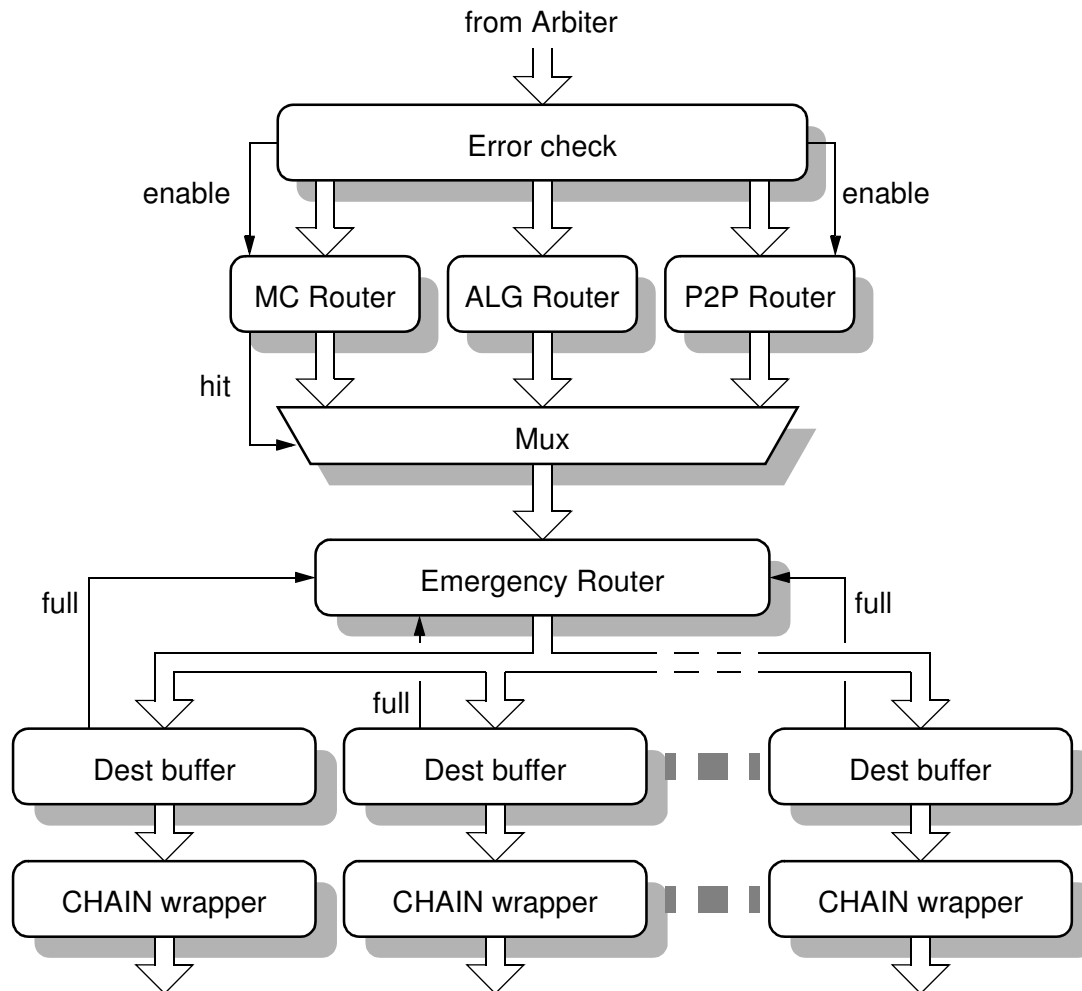

Packets are passed as complete 40- or 72-bit units from the Arbiter, together with an identifier of the Rx interface that the packet arrived through (for nearest-neighbour and default routing). The first stage of processing here is to identify errors. The second stage passes the packet to the appropriate routing engines – the multicast (MC) router is activated only if the packet is error-free and of multicast type, the point-to-point (P2P) handles point-to-point packets while the algorithmic (ALG) router handles nearest-neighbour packets and also deals with default and error routing. The output of the router stage is a vector of destinations to which the packet should be relayed. The third stage is the emergency routing mechanism for handling failed or congested links, which it detects using ‘full’ signals fed back from the individual destination output buffers.

10.4 Multicast (MC) router

The mc router uses the routing key in the mc packet to determine how to route the packet. The router has 1024 look-up entries, each of which has a mask, a key value, and an output vector.

The packet's routing key is compared with each entry in the mc router. For each entry it is first ANDed with the mask, then compared with the entry's key. If it matches, the entry's output vector is used to determine where the packet is sent; it can be sent to any subset (including all) of the local processors and the output links.

The matching is performed in a parallel ternary associative memory, with a RAM used to store the output vectors. The associative memory should be set up to ensure that at most one entry matches any incoming routing key. Behaviour is undefined if two entries match a routing key.

If no entry matches an mc packet's routing key then default routing is employed - the packet will be sent to the output link opposite the input link it arrived through. There is no default routing for packets from local processors - the router table must have a valid entry for every locally-sourced packet.

10.5 The point-to-point (p2p) router

The p2p router uses the 16-bit destination ID in a point-to-point packet to determine which output(s) the packet should be routed to. A 64K entry x 8-bit SRAM lookup table directs the p2p packet to:

- the local Monitor Processor, and/or
- adjacent chips via the appropriate links.

Each 8-bit entry has one bit which determines whether the packet is delivered to the local Monitor Processor, one bit for each of the six output links, plus a parity bit. Thus there is a form of broadcast capability available here.

10.6 The algorithmic (ALG) router

nn routing

Nearest-neighbour packets are used to initialise the system and to perform run-time flood-fill and debug functions. The routing function here is to send 'normal' nn packets that arrive from outside the node (i.e. via an Rx link) to the monitor processor and to send nn packets that are generated internally to the appropriate output (Tx) link(s). This is to support a flood-fill OS load process.

In addition, the 'direct' form of nn packet can be used by neighbouring systems to access System NoC resources. Here an nn 'write' packet (which is a direct type with a 32-bit payload) is used to write the 32-bit data defined in the payload to a 32-bit address defined in the address/operation field. An nn 'read' packet (which is a direct type without a 32-bit payload) uses the 32-bit address defined in the address/operation field to read from the System NoC and returns the result (as a 'normal' nn packet) to the neighbour that issued the original packet using the Rx link ID to identify that source. This 'direct' access to a neighbouring chip's principal resources can be used to investigate a non-functional chip, to re-assign the Monitor Processor from outside, and generally to get good visibility into a chip for test and debug purposes.

default and error routing

In addition, the algorithmic router performs default and error routing functions.

10.7 Time phase handling

The Router maintains a 2-bit time phase signal that is used to delete packets that are out-of date. The time phase logic operates as follows:

- locally-generated packets will have the current time phase inserted (where appropriate);
- a packet arriving from off-chip will have its time phase checked, and if it is two phases old it will be deleted (dropped to the local Monitor Processor).

10.8 Packet error handler

The packet error handler is a routing engine that simply flags the packet for routing to the local Monitor Processor if it detects any of the following:

- a packet parity error;
- a packet that is two time phases old;
- a packet that is the wrong length.

There must be a means for the Monitor Processor to recognise packets passed to it with errors. Rather than complicating the Communications Controller, this is probably better done by providing error information via the Router configuration registers.

10.9 Emergency routing

If a link fails (temporarily, due to congestion, or permanently, due to component failure) action will be taken at two levels:

- the blocked link will be detected in hardware and subsequent packets rerouted via the other two sides of one of the routing triangles of which the suspect link was an edge.
- the Monitor Processor will be informed. It will assess the problem, and take appropriate action:
 - if the problem was due to transient congestion, it will note the congestion but do nothing further;
 - if the problem was due to recurring congestion, it will negotiate and establish a new route for some of the traffic using this link;
 - if the problem appears permanent, it will reset the link (incurring some packet loss) and then, if this does not clear the problem, negotiate and establish new routes for all of the traffic using this link.

The hardware support for these processes include:

- default routing processes in adjacent nodes that are invoked by flagging the packet as an emergency type;
- mechanisms to inform the Monitor Processor of the problem;
- mechanisms the Monitor Processor can use to reset the link;
- means of inducing the various types of fault for testing purposes.

Emergency rerouting around the triangle requires additional emergency packet types for mc packets. p2p packets will find their own way to their destination following emergency routing.

10.10 Errant packets

In order to ensure that packets cannot circulate for ever within the system each packet includes a time phase field. This is set when the packet is launched, and if a packet arrives at a Router two time phases after it was launched it will be routed directly (and only) to the local Monitor Processor for error-handling purposes.

10.11 Pseudo-code description

The following pseudo-code describes the detailed operation of the Communications Router:

```
Pipeline stage 1: Error Checking
inputs:      72-bit Packet  p;
            3-bit  SourceID src;
local info:  2-bit TimePhase timePhase

Begin stage 1=====

% check error conditions
```

```

PPerr = (packetParity(p) == EVEN);           % parity error
TPerr = (src < 6) AND (p.timeStamp = timePhase EOR 0b10) % !! ST was 0b11
        AND (p.type == 0b0x);               % time phase error
LNerr = (p.lastSymbol != EOP);               % packet length error

error = PPerr OR TPerr OR LNerr;

% update counters

if (PPerr) incPacketParityErrorCounter();
if (TPerr) incPacketTimeStampErrorCounter();
if (LNerr) incPacketLengthErrorCounter();

incPacketCounter();

% insert Time Phase

if (src == 7) AND (p.type == 0b0x) {         % local p2p or mc packet
    p.timeStamp = timePhase;
    ParityFix(p.parity);
}

% engage appropriate Router

enMC = (not error) AND (p.type == MC) AND (p.emergencyRouting != 0b10);
enP2P = (not error) AND (p.type == P2P);

End stage 1=====

Pipeline stage 2: Routing
inputs:      72-bit Packet   p;
             3-bit SourceID src;
             Booleans PPerr, TPerr, LNerr, error;
local info:  5-bit MonitorProcessorID mpID;

Begin stage 2=====

% enable relevant Router

if (enMC) {hit, MCvect} = MCrouter(p.MCkey);
else hit = 0;
if (enP2P) {P2Pvect} = P2Prouter(p.destID);

% default emergency routing vector

erVect = 0;

% send all errors to Monitor Processor

if (error) vect = 2^(mpID+6);
else {

% routing depends on packet type

case (p.type) {
MC: if (hit) vect = MCvect;
    else if (src == 7)
        vect = 2^(mpID+6)           % local: miss => error
    else if (p.emergencyRouting == 0b0x)
        vect = 2^[(src+3)mod6];     % normal default
    else if (p.emergencyRouting == 0b11)
        vect = 2^[(src+2)mod6];     % ER 2nd stage default
    else vect = 0;                  % ER only
    if (p.emergencyRouting == 0b01 or 0b10)
        erVect = 2^[(src-1)mod6]; % ER 1st stage

P2P:      vect = P2Pvect;

NN: if (src == 7) {                 % local source

```



```

        incDiscardedPacketCounter();           % record packet loss
        doSomethingWithMonitorProc();         % try to revive monitor?
    } else {
        sendPacketTo(p, buff[mpID+6]);        % send to Monitor Proc
        incDroppedPacketCounter();           % record packet loss
        sendToSystemController(bFull);       % report blocked links to system
controller
    }
}

% can now proceed

for (i = 0; i++; i<6) {
    if (NOT bFull[i]) {                      % send only if link open
        p2 = p;                               % copy packet

        case (p.type) {

MC:   if (vect.bit[i] OR erVect.bit[i]
        OR (bFull[(i+1)mod6] AND vect.bit[(i+1)mod6])) {
            if (vect.bit[i]) {
                if (bFull[(i+1)mod6] AND vect.bit[(i+1)mod6])
                    p2.emergencyRouting = 0b01;    % normal + ER 1st
                    incERpacketCounter();          % record ER
                else p2.emergencyRouting = 0b00;    % normal
            } elseif (bFull[(i+1)mod6] AND vect.bit[(i+1)mod6]) {
                p2.emergencyRouting = 0b10;        % ER 1st stage
                incERpacketCounter();              % record ER
            } elseif (erVect.bit[i]) {
                p2.emergencyRouting = 0b11;        % ER 2nd stage
            }
            ParityFix(p2.parity);
            sendPacketTo(p2, buff[i]);
        }

P2P:  if (vect.bit[i]
        OR (bFull[(i+1)mod6] AND vect.bit[(i+1)mod6])) {
            sendPacketTo(p2, buff[i]);
        }

NN:   if (vect.bit[i]) {
            sendPacketTo(p2, buff[i]);
        }
    }
}
for (i = 6; i++; i<26) {
    if (vect.bit[i] AND NOT bFull[i]) {      % copy packet
        p2 = p;
        if (p2.type == NN) {
            p2.route = src;
        }
        sendPacketTo(p2, buff[i]);
    }
}

End stage 3=====

```

10.12 Registers

The Router configuration and error-reporting registers are detailed in section 15. on page 60.

10.13 Fault-tolerance

The Communications Router has limited fault-tolerance capacity, mainly coming down to mapping out a failed multicast router entry. This is a useful mechanism as the multicast router dominates the silicon area of the Communications Router.

Fault insertion

- enable Router to flip packet parity bits?

Fault detection

- packet parity errors
- packet time-phase errors
- packet unroutable errors (e.g. a locally-sourced multicast packet which doesn't match any entry in the multicast router).
- wrong packet length.

Fault isolation

- a mechanism is required to disable a multicast router entry if it fails. Possible just an 'entry valid' bit?

Reconfiguration

- since all multicast router entries are identical the function of any entry can be relocated to a spare entry (within the same segment of the router if segmentation is used to save power).
- if a router (segment) becomes full a global reallocation of resources can move functionality to a different router (segment)

10.14 Test

production test

The ternary CAM used in the multicast router should have suitable access for parallel testing purposes, so that a processor can write the same value to all locations and see if an input with 1 bit flipped results in a hit or a miss.

All RAMs should have read-write access for test purposes.

start-up test

run-time test

10.15 Notes

- The Router will require a number of traffic monitor features, e.g. packet counters, congestion indicators, count packet under match & mask, dropped packet count, emergency routing count, count on each output link, ...

11. Inter-chip transmit and receive interfaces

Inter-chip communication is implemented by extending CHAIN links from chip to chip. In order to sustain CHAIN link throughput, there is a protocol conversion at each chip boundary from standard CHAIN 1-of-5 (including EOP) return-to-zero to 2-of-7 non-return-to-zero. Each conversion maps two 2-bit CHAIN symbols to a single 4-bit 2-of-7 symbol.

11.1 Features

- transmit (Tx) interface:
 - converts two on-chip 1-of-5 RTZ symbols into one off-chip 2-of-7 NRZ symbol;
 - control input to induce a fault;
 - failure detection output.
 - fault reset input.
- receive (Rx) interface:
 - converts one off-chip 2-of-7 NRZ symbol into two on-chip 1-of-5 RTZ symbols;
 - control input to induce a fault;
 - failure detection output.
 - fault reset input.
 - adds source tag to packet for default routing [unless this is done in the Communications NoC arbiter?]

11.2 Programmer view

There are no programmer-accessible features implemented in these interfaces. In normal operation these interfaces provide transparent connectivity between the routing network on one chip and those on its neighbours.

11.3 Fault-tolerance

The fault inducing, detecting and resetting functions are controlled from the System Controller (see 'System Controller' on page 58).

Fault insertion

- an input controlled by the System Controller causes the interface to deadlock

Fault detection

- an output to the System Controller indicates deadlock

Fault isolation

- the interface can be disabled to isolate the chip-to-chip link. This may be the same input from the System Controller that is used to insert a fault.

Reconfiguration

- the link interface can be reset by the System Controller to attempt recovery from a fault
- the link interface can be isolated and an alternative route used

11.4 Test

production test

start-up test

run-time test

12. System NoC

The System NoC has a primary function of connecting the ARM968 processors to the SDRAM interface. It is also used to connect the Monitor Processor to system control and test functions, and for a variety of other purposes.

The System NoC is generated by the Silistix CHAINworks tool.

12.1 Features

- supports full bandwidth block transfers between the SDRAM and the ARM968 processors.
- the Router is an additional initiator for system debug purposes.
- can be reset (in subsections?) to clear deadlocks.
- multiple targets:
 - SDRAM interface - ARM PL340
 - System RAM
 - System ROM
 - Ethernet interface
 - System Controller
 - Router configuration register

12.2 Fault-tolerance

Fault insertion

Fault detection

Fault isolation

Reconfiguration

12.3 Test

production test

start-up test

run-time test

13. SDRAM interface

The SDRAM interface connects the System NoC to an off-chip SDRAM device. It is the ARM PL340, described in ARM document DDI 0331D.

13.1 Features

- control for external Mobile DDR SDRAM memory device
- memory request queue with one entry per ARM968 processor
- out of order request sequencing to maximise memory throughput
- AXI interface to System NoC

13.2 Register summary

Base address: 0xea000000 (buffered write), 0xfa000000 (unbuffered write).

User registers

The following registers allow normal user programming of the PL340 SDRAM interface:

Name	Offset	R/W	Function
r0: status	0x0	R	memory controller status
r1: command	0x4	W	PL340 command
r2: direct	0x8	W	direct command
r3: mem_cfg	0xC	R/W	memory configuration
r4: refresh_prd	0x10	R/W	refresh period
r5: CAS_latency	0x14	R/W	CAS latency
r6: t_dqss	0x18	R/W	write to DQS time
r7: t_mrd	0x1C	R/W	mode register command time
r8: t_ras	0x20	R/W	RAS to precharge delay
r9: t_rc	0x24	R/W	active bank x to active bank x delay
r10: t_rcd	0x28	R/W	RAS to CAS minimum delay
r11: t_rfc	0x2C	R/W	auto-refresh command time
r12: t_rp	0x30	R/W	precharge to RAS delay
r13: t_rrd	0x34	R/W	active bank x to active bank y delay
r14: t_wr	0x38	R/W	write to precharge delay
r15: t_wtr	0x3C	R/W	write to read delay
r16: t_xp	0x40	R/W	exit power-down command time
r17: t_xsr	0x44	R/W	exit self-refresh command time

Name	bits	R/W	Function
QoS	20:18	R/W	selects the 4-bit QoS field from the AXI ARID
act	22:21	R/W	active chips: number for refresh generation

register 4: refresh period

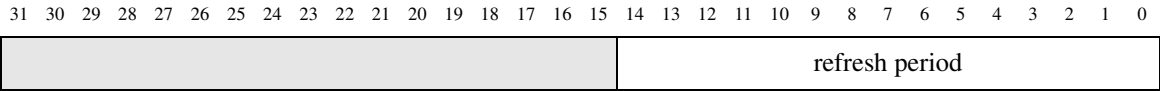

The function of this field is described in the table below:

Name	bits	R/W	Function
refresh period	14:0	R/W	memory refresh period in memory clock cycles

register 5: CAS latency

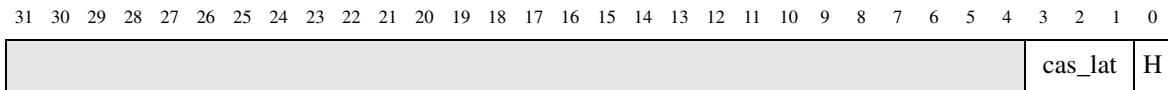

The functions of these fields are described in the table below:

Name	bits	R/W	Function
H	0	R/W	CAS half cycle - must be set to 1'b0
cas_lat	3:1	R/W	CAS latency in memory clock cycles

register 6: t_dqss

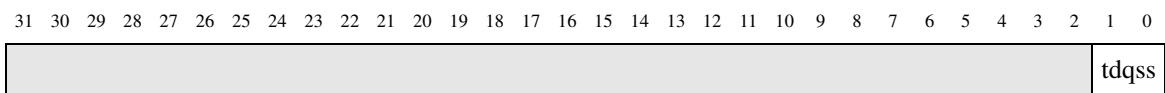

The function of this field is described in the table below:

Name	bits	R/W	Function
tdqss	1:0	R/W	write to DQS in memory clock cycles

register 7: t_mrd

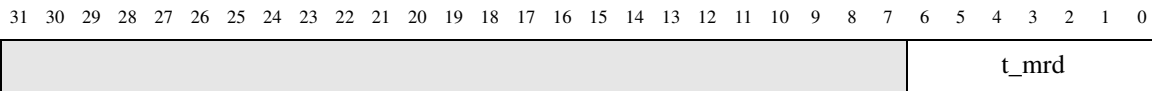

The function of this field is described in the table below:

Name	bits	R/W	Function
t_mrd	6:0	R/W	mode reg cmdnd time in memory clock cycles

register 8: t_ras

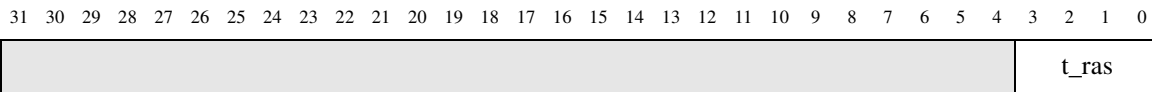

The function of this field is described in the table below:

Name	bits	R/W	Function
t_ras	3:0	R/W	RAS to precharge time in memory clock cycles

register 9: t_rc

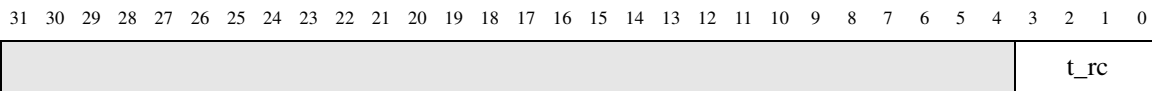

The function of this field is described in the table below:

Name	bits	R/W	Function
t_rc	3:0	R/W	Bank x to bank x delay in memory clock cycles

register 10: t_rcd

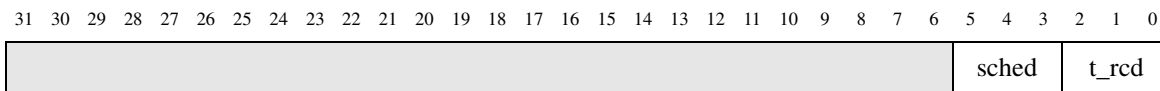

The functions of these fields are described in the table below:

Name	bits	R/W	Function
t_rcd	2:0	R/W	RAS to CAS min delay in memory clock cycles
sched	5:3	R/W	RAS to CAS min delay in ack cycles -3

id_n_cfg

31 30 29 28 27 26 25 24 23 22 21 20 19 18 17 16 15 14 13 12 11 10 9 8 7 6 5 4 3 2 1 0



The functions of these fields are described in the table below:

Name	bits	R/W	Function
E	0	R/W	QoS enable
N	1	R/W	minimum QoS
QoS_max	9:2	R/W	maximum QoS

chip_n_cfg

31 30 29 28 27 26 25 24 23 22 21 20 19 18 17 16 15 14 13 12 11 10 9 8 7 6 5 4 3 2 1 0

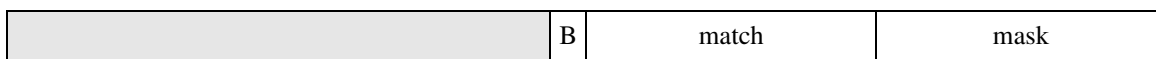

There is one of these registers for each external chip that is supported. The functions of these fields are described in the table below:

Name	bits	R/W	Function
mask	7:0	R/W	address mask
match	15:8	R/W	address match
B	16	R/W	bank-rol-column/row-bank-column

user_status

31 30 29 28 27 26 25 24 23 22 21 20 19 18 17 16 15 14 13 12 11 10 9 8 7 6 5 4 3 2 1 0



The function of this field is described in the table below:

Name	bits	R/W	Function
status	7:0	R/W	value of user_status[7:0] primary input pins

user_config

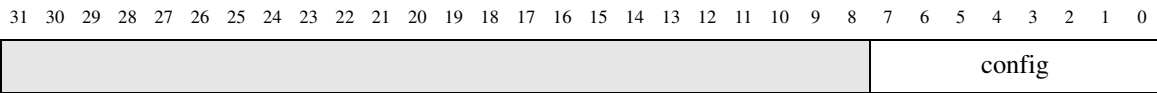

The function of this field is described in the table below:

Name	bits	R/W	Function
config	7:0	R/W	sets user_config[7:0] primary output pins

13.4 Fault-tolerance

Fault insertion

Fault detection

Fault isolation

Reconfiguration

13.5 Test

production test

start-up test

run-time test

14. System Controller

The System Controller incorporates a number of functions used by the Monitor Processor for system start-up, fault-tolerance testing (invoking, detecting and resetting faults), general performance monitoring, and such like. At present, the exact layout of the registers has not been defined and bits and functionality may move between registers as the design progresses. The descriptions below are therefore given in general terms.

To provide some tolerance to runaway code on any processor it is expected that access to these registers (and similar functionality elsewhere on the chip) will only be permitted in a privileged CPU mode. A control bit can be provided to disable this if necessary, so that user mode code can also access these resources. Access might also be restricted just to the monitor processor at certain times. A global watchdog timer is also provided here which the monitor processor is expected to refresh. Failure to do so results in the chip being reset (and a new monitor chosen? - how?)

14.1 Register summary

Base address: 0xed000000 (buffered write), 0xfd000000 (unbuffered write).

Name	Offset	R/W	Function
CPU Reset	0x0000	R/W	Each bit allows a processor to be reset
CPU Interrupt	0x0004	R/W	Each bit generates an interrupt at a processor
CPU Clk disable	0x0008	R/W	Each bit disables the clock of a processor
Monitor ID	0x0010	R/W	ID of monitor processor
Set CPU OK	0x0020	R/W	Writing a 1 sets a CPU OK bit
Clr CPU OK	0x0024	R/W	Writing a 1 clears a CPU OK bit
Reset Code	0x0030	RO	Indicates cause of last chip reset
I/O port	0x0040	R/W	Access to external I/O pins
Misc control	0x0050	R/W	Miscellaneous control bits
Misc status	0x0054	RO	Miscellaneous status bits
Misc test	0x0100	R/W	Miscellaneous chip test control bits
Watchdog	0x1000	Various	Base of ADK watchdog registers

14.2 Register details

CPU Reset, Interrupt, Clk disable

These three registers contain individual bit enables for each processor. They are all initialised to zero on reset. Setting a bit will either reset, interrupt or disable the clock of a particular processor. It is expected that only the monitor processor will access these registers.

Monitor ID

This register is written with the ID of the processor which has been chosen as the monitor processor. Its output is required by the router (via the Router Control Register) in order to route error packets to the monitor processor. It is initialised by power-on reset to an invalid value which does not refer to any processor. Other forms of reset do not change this register.

Set/Clr CPU OK

These two registers contain individual bits for each processor and are used to indicate which processors are operational. Writing a 1 to a bit in the Set register will set a bit and writing a 1 to a bit in the Clr register will clear a bit. This mechanism ensures that the state is updated atomically when several processors write these register 'simultaneously'. When read, the both registers return the same value, being a bit mask indicating the current set of operation processors. All bits are cleared when the chip is reset.

I/O port

The I/O port controls a small number of I/O pins on the chip. A minimum of two would allow a serial I/O interface such as I²C to be implemented. LEDs may also be driven by the I/O pins.

Misc control

This register contains a collection of bits which provide general chip control. The following functions may be provided - PLL control, bits to allow User mode access to various parts of the system, direction control for the I/O pins, etc, etc.

Misc status

This register provides a collection of status bits. For example, reason for last reset, state of the off-chip links, 'one-shot' bit which reads as 1 only once following reset (used to assist in selecting monitor processor), PLL lock status, etc, etc.

Test control

The test control register provides control for on-chip testing. For example, bits to simulate error conditions in various parts of the chip, bits to reconfigure pins to allow testing to proceed, etc, etc.

Watchdog

This is implemented using the watchdog component from the AMBA design kit. It must be periodically written (by the monitor processor) to prevent the watchdog timer from expiring and resetting the chip.

NOTE: What is the timer period, & do we want to try to force a different monitor processor when the watchdog expires?

14.3 Fault-tolerance

Fault insertion

Fault detection

Fault isolation

Reconfiguration

14.4 Test

production test

start-up test

run-time test

15. Router configuration registers

The Router is highly configurable, and the Monitor Processor is responsible for initialising it and updating it when necessary. The Router configuration registers are accessed via the system NoC.

15.1 Features

- used to set up the associative routing tables.
- give read/write access to the Router tables for test purposes.
- access for Monitor Processor to Router packet error information and traffic counters.

15.2 Register summary

Base address: **0xec000000 (buffered write), 0xfc000000 (unbuffered write).**

Name	Offset	R/W	Function
r0: control	0x0	W	Router control register
r1: error flags	0x4	R	Router error flags
r2: packet count	0x8		
r3: time stamp	0xC		
key[1023:0]	0x4000	W	MC Router key values
mask[1023:0]	0x8000	W	MC Router mask values
route[1023:0]	0xC000	W	MC Router routing word values
p2p[65535:0]	0x10000	W	p2p Router routing entries

15.3 Register details

register 0: Router control register

31	30	29	28	27	26	25	24	23	22	21	20	19	18	17	16	15	14	13	12	11	10	9	8	7	6	5	4	3	2	1	0
								wait2[3:0]					wait1[3:0]					MP[4:0]					M								

The functions of these fields are described in the table below:

Name	bits	R/W	Function
M	0	W	send errant packets to the Monitor Processor
MP[4:0]	12:8	W	Monitor Processor ID number
wait1[3:0]	19:16	W	Router wait time before emergency routing
wait2[3:0]	23:20	W	Router wait time before dropping packet

15.4 Fault tolerance

Fault insertion

Fault detection

Fault isolation

Reconfiguration

15.5 Test

production test

start-up test

run-time test

15.6 Notes

- time stamp: writeable, updated on newer incoming packet and by internal counter?
- dropped packet counter, emergency routed counter, ...?

16. Ethernet MII interface

The SpiNNaker systems connects to a host machine via Ethernet links. Each SpiNNaker chip includes an Ethernet MII interface, although only a few of the chips are expected to use this interface. These chips will require an external PHY.

The interface hardware operates at the frame level. All higher-level protocols will be implemented in software running on the local monitor processor.

16.1 Features

- support for full-duplex 10 and 100 Mbit/s Ethernet via off-chip PHY
- outgoing frame buffer, for one maximum-size frame
 - outgoing frame control, CRC generation and inter-frame gap insertion
- incoming frame buffer, for two maximum-size frames
 - incoming frame descriptor buffer, for up to 48 frame descriptors
 - incoming frame control with length and CRC check
 - support for unicast (with programmable MAC address), multicast, broadcast and promiscuous frame capture
 - receive error filter
- internal loop-back for test purposes
- general-purpose IO for PHY management (SMI) and PHY reset
- interrupt sources for frame-received, frame-transmitted and PHY (external) interrupt

[The interface does not provide support for half-duplex operation (as required by a CSMA/CD MAC algorithm), jumbo or VLAN frames.]

16.2 Using the Ethernet MII interface

The Ethernet driver software must observe a number of sequence dependencies in initialising the PHY and setting-up the MAC address before the Ethernet interface is ready for use.

Details of these issues are documented in “SpiNNaker AXI-MII module” by Brendan Lynskey. The latest version of this (currently version 009, November 2007) will be held in the SpiNNaker document repository.

16.3 Register summary

Base address: 0xeb000000 (buffered write), 0xfb000000 (unbuffered write).

User registers

The following registers allow normal user programming of the Ethernet interface:

Name	Offset	R/W	Function
Tx frame buffer	0x0000	W	Transmit frame RAM area
Rx frame buffer	0x4000	R	Receive frame RAM area
Rx desc RAM	0x8000	R	Receive descriptor RAM area
r0: gen command	0xC000	W	General command

Name	Offset	R/W	Function
r1: gen status	0xC004	R	General status
r2: Tx length	0xC008	W	Transmit frame length
r3: Tx command	0xC00C	W	Transmit command
r4: Rx command	0xC010	W	Receive command
r5: MAC addr ls	0xC014	W	MAC address low bytes
r6: MAC addr hs	0xC018	W	MAC address high bytes
r7: PHY control	0xC01C	W	PHY control
r8: IRQ status	0xC020	R	Interrupt status
r9: Rx buf rd ptr	0xC024	R	Receive frame buffer read pointer
r10: Rx buf wr ptr	0xC028	R	Receive frame buffer write pointer
r11: Rx dsc rd ptr	0xC02C	R	Receive descriptor read pointer
r12: Rx dsc wr ptr	0xC030	R	Receive descriptor write pointer

Test registers

In addition, there are test registers that will not normally be of interest to the programmer:

Name	Offset	R/W	Function
r13: Rx host state	0xC034	R	Receive host FSM state (debug & test use)
r14: Rx MII state	0xC038	R	Receive MII FSM state (debug & test use)
r15: Tx MII state	0xC03C	R	Transmit MII FSM state (debug & test use)

See “SpiNNaker AXI-MII module” by Brendan Lynskey version 009, November 2007 for further details of the test registers.

16.4 Register details

register 0: General command register

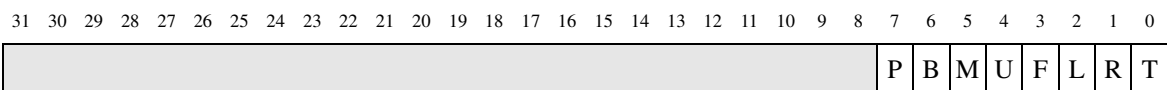

The functions of these fields are described in the table below:

Name	bits	R/W	Function
T	0	W	Transmit system enable
R	1	W	Receive system enable

Name	bits	R/W	Function
L	2	W	Loopback enable
F	3	W	Receive error filter enable
U	4	W	Receive unicast packets enable
M	5	W	Receive multicast packets enable
B	6	W	Receive broadcast packets enable
P	7	W	Receive promiscuous packets enable

register 1: General status register

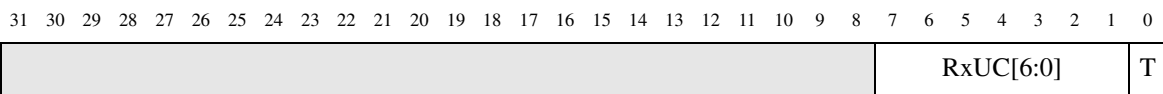

The functions of these fields are described in the table below:

Name	bits	R/W	Function
T	0	R	Transmit MII interface active
RxUC[6:0]	7:1	R	Received unread frame count

register 2: Transmit frame length

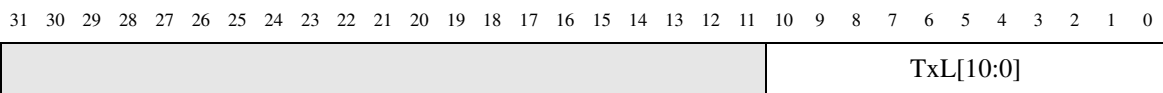

The functions of these fields are described in the table below:

Name	bits	R/W	Function
TxL[10:0]	10:0	W	Length of transmit frame {60 - 1514 bytes}

register 3: Transmit command register

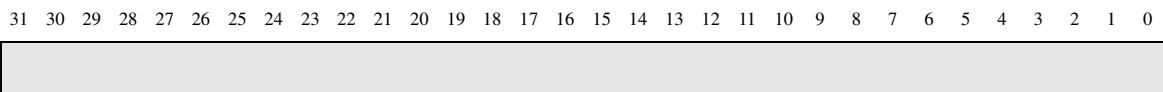

Any write to register 3 causes the transmission of a frame.

register 4: Receive command register

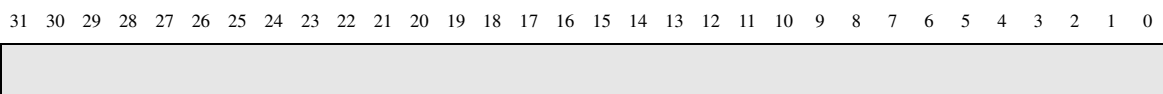

Any write to register 4 indicates that the current receive frame has been processed and decrements

the received unread frame count in register 1.

register 5: MAC address low bytes

31 30 29 28 27 26 25 24	23 22 21 20 19 18 17 16	15 14 13 12 11 10 9 8	7 6 5 4 3 2 1 0
MAC3[7:0]	MAC2[7:0]	MAC1[7:0]	MAC0[7:0]

The functions of these fields are described in the table below:

Name	bits	R/W	Function
MAC0[7:0]	7:0	W	MAC address byte 0
MAC1[7:0]	15:8	W	MAC address byte 1
MAC2[7:0]	23:16	W	MAC address byte 2
MAC3[7:0]	31:24	W	MAC address byte 3

register 6: MAC address high bytes

31 30 29 28 27 26 25 24	23 22 21 20 19 18 17 16	15 14 13 12 11 10 9 8	7 6 5 4 3 2 1 0
		MAC5[7:0]	MAC4[7:0]

The functions of these fields are described in the table below:

Name	bits	R/W	Function
MAC4[7:0]	7:0	W	MAC address byte 4
MAC5[7:0]	15:8	W	MAC address byte 5

register 7: PHY control

31 30 29 28 27 26 25 24	23 22 21 20 19 18 17 16	15 14 13 12 11 10 9 8	7 6 5 4 3 2 1 0
			C E O I R

The functions of these fields are described in the table below:

Name	bits	R/W	Function
R	0	W	PHY reset (active low)
I	1	R	SMI data input
O	2	W	SMI data output
E	3	W	SMI data output enable
C	4	W	SMI clock (active rising)

register 8: Interrupt clear

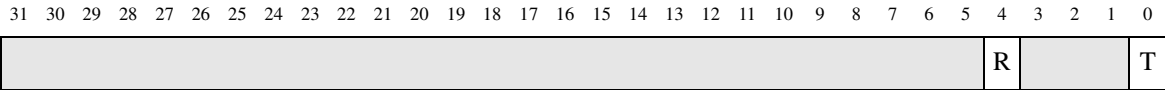

The functions of these fields are described in the table below:

Name	bits	R/W	Function
T	0	W	Clear transmit interrupt request
R	4	W	Clear receive interrupt request

Writing a 1 to bit [0] if this register clears a pending transmit frame interrupts. Writing a 1 to bit [4] clears a pending receive frame interrupt. There is no requirement to write a 0 to these bits other than in order to prevent unintentional interrupt clearance.

register 9: Receive frame buffer read pointer

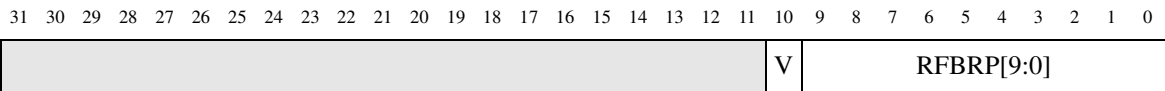

The functions of these fields are described in the table below:

Name	bits	R/W	Function
RFBRP[9:0]	9:0	R	Receive frame buffer read pointer
V	10	R	Rollover bit - toggles on address wrap-around

register 9: Receive frame buffer write pointer

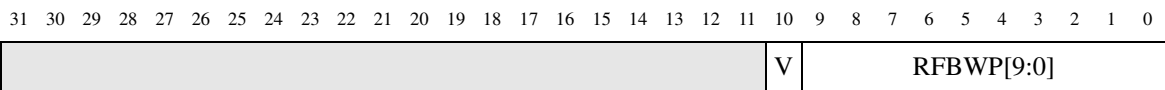

The functions of these fields are described in the table below:

Name	bits	R/W	Function
RFBWP[9:0]	9:0	R	Receive frame buffer write pointer
V	10	R	Rollover bit - toggles on address wrap-around

17. System RAM

The System RAM is an additional 128 kByte block of on-chip RAM used primarily by the Monitor Processor to enhance its program and data memory resources as it will be running more complex (though less time-critical) algorithms than the fascicle processors.

As the choice of Monitor Processor is made at start-up (and may change during run-time for fault-tolerance purposes) the System RAM is made available to whichever processor is Monitor Processor via the System NoC. It is probably important that accesses by the Monitor Processor to the System RAM are non-blocking as far as SDRAM accesses by the fascicle processors are concerned, so the System NoC should ensure this is the case.

The System RAM may also be used by the fascicle processors to communicate with the Monitor Processor and with each other, should the need arise.

17.1 Features

- 128 kB of SRAM, available via the System NoC.
- can be disabled to model complete failure for fault-tolerance testing.
- can we include parity or ECC to improve fault-tolerance?

17.2 Address location

Base address: 0xee000000 (buffered write), 0xfe000000 (unbuffered write).

17.3 Fault-tolerance

Fault insertion

- It is straightforward to corrupt the contents of the System RAM to model a soft error – any processor can do this. It is not clear how this would be detected.
- The System RAM can be disabled to model a total failure.

Fault detection

- The Monitor Processor may perform a System RAM test at start-up, and periodically thereafter.
- It is not clear how soft errors can be detected without some sort of parity or ECC system.

Fault isolation

- Faulty words in the System SRAM can be mapped out of use.

Reconfiguration

- For hard failure of a single bit, avoid using the word containing the failed bit.
- If the System RAM fails completely the only option is to use the SDRAM instead, which will probably result in compromised performance for the fascicle processors due to loss of SDRAM bandwidth. An option then would be to relocate some of the fascicle processors' workload to another chip.

17.4 Test

production test

- run standard memory test patterns from one of the processing subsystems.

start-up test

run-time test

S
p
i
N
N
a
k
e
r

18. Boot ROM

18.1 Features

- a small on-chip ROM to provide minimal support for:
- initial self-test, and Monitor Processor selection
- Router initialisation for bootstrapping
- system boot.

The Test chip will have a minimal Boot ROM sufficient to enable the loading of code from an external I²C ROM using the GPIO[1:0] pins as an I²C interface.

18.2 Address location

Base address: **0xef000000 (buffered write), 0xff000000 (unbuffered write).**

18.3 Fault-tolerance

Fault insertion

Fault detection

Fault isolation

Reconfiguration

18.4 Test

production test

start-up test

run-time test

19. Boot, test and debug support

19.1 Features

- means of booting system and flood-filling the distributed operating system efficiently at start-up.
- back-up boot mechanism in case Boot ROM fails.
- access to ARM968 EmbeddedICE features.
- sundry features to facilitate production, start-up and run-time testing.

19.2 Issues

At system power-up we can make few assumptions about what is and isn't working within the system. What is the minimum that must work for each chip to run internal self-tests, appoint a Monitor Processor, and then participate with its peers in an efficient bootstrap process that loads a distributed operating system into every node?

The inter-chip communication system is very soft and must be initialised before any mc or p2p communication can take place. But each node has no initial knowledge of where it is in the system, so how can it initialise the Router?

The ultimate system is large, so the bootstrap process must be efficient and employ flood-fill algorithms.

19.3 Boot algorithm

- Following power-on reset, each chip will perform internal self-tests and a Monitor Processor will be selected, probably as a result of asynchronous arbitration processes. The node will go into receptive mode, relying on the default boot routing process to communicate.
- The host system will begin sending OS load packets in nearest-neighbour format, tagged with sequence numbers, to the node to which it is directly connected. All nodes receive all incoming nn packets and, if they have not been seen before, retransmit them to all neighbours. Any packet which has been seen before will be dropped and not retransmitted.
- Once all sequence numbers have been received a node will perform a CRC check and, if this is correct, begin executing the loaded OS code.

19.4 Fault-tolerance

Fault insertion

Fault detection

Fault isolation

Reconfiguration

19.5 Test

production test

start-up test

run-time test

20. Input and Output signals

The SpiNNaker chip has the following IO, power and ground pins. All IO is assumed to operate at 1.8v with CMOS logic levels; the SDRAM interface is tightly-specified 1.8v LVCMOS. All other IOs are non-critical, though output delay affects link throughput.

The IOs are listed and enumerated in the tables below for the full chip [and test chip].

20.1 External SDRAM interface

Signal	Type	Drive	Function	#	[#]
DQ[31:0]	I/O	8mA B	Data	1-32	1-32
A[12:0]	O	4mA B	Address	33-45	33-45
CK, CK#	O	8mA B	True and inverse clock	46, 47	46, 47
CKE	O	4mA B	Clock enable	48	48
CS#	O	4mA B	Chip select - tie to Gnd	-	-
RAS#	O	4mA B	Row address strobe	49	49
CAS#	O	4mA B	Column address strobe	50	50
WE#	O	4mA B	Write enable	51	51
DM[3:0]	O	8mA B	Data mask	52-55	52-55
BA[1:0]	O	4mA B	Bank address	56, 57	56, 57
DQS[3:0]	I/O	8mA B	Data strobe	58-61	58-61
VddQ[14:0]	1.8v		Power for SDRAM pins	62-76	62-76
VssQ[14:0]	Gnd		Ground for SDRAM pins	77-91	77-91

Noise: $10\text{nH} * (42 * 18\text{mV/nH} + 20 * 11\text{mV/nH}) / 15 = 650 \text{ mV}$ ground/power bounce.

20.2 JTAG

Signal	Type	Drive	Function	#	[#]
TRST	I	D	Test reset	92	92
TCK	I	D	Test clock	93	93
TMS	I	D	Test mode select	94	94
TDI	I	D	Test data in	95	95
TDO	O	4mA A	Test data out	96	96

20.3 Communication links

Signal	Type	Drive	Function	#	[#]
L0in[6:0]	I	D	link 0 2-of-7 input code	97-103	97-103
L0inA	O	4mA B	link 0 input acknowledge	104	104
L0out[6:0]	O	4mA B	link 0 2-of-7 output code	105-111	105-111
L0outA	I	D	link 0 output acknowledge	112	112
L1in[6:0]	I	D	link 1 2-of-7 input code	113-119	113-119
L1inA	O	4mA B	link 1 input acknowledge	120	120
L1out[6:0]	O	4mA B	link 1 2-of-7 output code	121-127	121-127
L1outA	I	D	link 1 output acknowledge	128	128
L2in[6:0]	I	D	link 2 2-of-7 input code	129-135	129-135
L2inA	O	4mA B	link 2 input acknowledge	136	136
L2out[6:0]	O	4mA B	link 2 2-of-7 output code	137-143	137-143
L2outA	I	D	link 2 output acknowledge	144	144
L3in[6:0]	I	D	link 3 2-of-7 input code	145-151	145-151
L3inA	O	4mA B	link 3 input acknowledge	152	152
L3out[6:0]	O	4mA B	link 3 2-of-7 output code	153-159	153-159
L3outA	I	D	link 3 output acknowledge	160	160
L4in[6:0]	I	D	link 4 2-of-7 input code	161-167	-
L4inA	O	4mA B	link 4 input acknowledge	168	-
L4out[6:0]	O	4mA B	link 4 2-of-7 output code	169-175	-
L4outA	I	D	link 4 output acknowledge	176	-
L5in[6:0]	I	D	link 5 2-of-7 input code	177-183	-
L5inA	O	4mA B	link 5 input acknowledge	184	-
L5out[6:0]	O	4mA B	link 5 2-of-7 output code	185-191	-
L5outA	I	D	link 5 output acknowledge	192	-
VddL[5:0]	1.8v		Power for link pins	193-198	161-164
VssL[5:0]	Gnd		Ground for link pins	199-204	165-168

Noise: $10\text{nH} * (18 * 11\text{mV/nH}) / 6 = 330 \text{ mV}$ ground/power bounce.

20.4 Ethernet MII

Signal	Type	Drive	Function	#	[#]
RX_CLK	I	D	Receive clock	205	145
RX_D[3:0]	I	D	Receive data	206-209	146-149
RX_DV	I	D	Receive data valid	210	150
RX_ERR	I	D	Receive data error	211	151
TX_CLK	O	2mA A	Transmit clock	212	152
TX_D[3:0]	O	2mA A	Transmit data	213-216	153-156
TX_EN	O	2mA A	Transmit data valid	217	157
TX_ERR	O	2mA A	Force transmit data error	218	158
MDC	O	2mA A	Management interface clock	219	159
MDIO	I/O	2mA A	Management interface data	220	169
PHY_RST	O	2mA A	PHY reset (optional)	221	170
PHY_IRQ	I	D	PHY interrupt (optional)	222	171
VddE	1.8v		Power for Ethernet MII pins	223	-
VssE	Gnd		Ground for Ethernet MII pins	224	-

Noise: $10\text{nH} * (9 * 3\text{mV/nH}) = 270\text{mV}$ ground/power bounce.

20.5 Miscellaneous

Signal	Type	Drive	Function	#	[#]
GPIO[3:0]	IO	4mA A	General-purpose IO	225-228	172-175
ResetIn	I	CSD	Chip reset	229	176
ResetOut	O	4mA A	Daisy-chain reset out	230	-
Test	I	D	Chip test mode	231	177
EtherMux	I	D	select Ethernet MII or Link 3	-	178
Clk10MIn	I	D	Main input clock - 10MHz	232	179
Clk10MOut	O	4mA A	Daisy-chain 10MHz clock out	233	-
Clk32kIn	I	CS	Slow (global) 32kHz clock	234	180
Clk32kOut	O	4mA A	Daisy-chain 32kHz clock out	235	-
VddM	1.8v		Power for miscellaneous pins	236	-
VssM	Gnd		Ground for miscellaneous pins	237	-
Vdd[7:0]	1.2v		Power for core logic	238-245	181-184
Vss[7:0]	Gnd		Ground for core logic	246-253	185-188
VddP[3:0]	1.2v		Power for PLLs	254-257	189-192
VssP[3:0]	Gnd		Ground for PLLs	258-261	193-196

Noise: $10\text{nH} * (5 * 5\text{mV/nH}) = 250\text{mV}$ ground/power bounce.

21. Area estimates

We are targeting a UMC 130nm process 10mm x 10mm die. (EuroPractice runs on this process are multiples of 5mm x 5mm. The test chip will be 5mm x 5mm.)

The Artisan in-line pads for this process are 60 μm x 293 μm , but EuroPractice recommends a minimum bond pad pitch of 90 μm , so we can get 49 IOs on each side of the test chip.

Assumptions

- RAM is around $2\mu\text{m}^2/\text{bit}$ = 3M T/mm².
- logic is 0.2 x the density of RAM = 100k gates/mm².
- The core area (excluding pads) is 9.414 x 9.414 [4.414 x 4.414] = 88.6 [19.48] mm².

Estimates

Using these assumptions we total up the core logic area for the full [test] chip as follows:

- The processor nodes = 20 [3] x 3.6 = 72 [10.8] mm².
 - An ARM968 with 32 kByte I-RAM and 64 kByte D-RAM is 3.3 mm².
 - DMA, interrupt, counter/timer, communications controllers: 20 k gates = 0.2 mm².
 - Communications and System NoC interfaces = 0.1 mm².
- The Communications NoC = 7.2 [3.7] mm².
 - The associative router with 1024 [512] associative entries is ~ 7 [3.5] mm².
 - Communications network fabric ~ 0.2 mm².
- The System NoC = 11 [3.5] mm².
 - The 128 [32] kByte System RAM is 2 [0.5]mm².
 - The Boot ROM is small ~ 0.1 mm².
 - The System Controller with 20k gates is 0.2 mm².
 - The PL340 SDRAM controller with 60k gates is 0.7 mm².
 - The network fabric is = 8 [2] mm².
- Boot, test and debug, PLLs = 0.5 mm².

Total area

The total core logic area is thus 72 [10.8] + 7.2 [3.7] + 11 [3.5] + 0.5 = 90.7 [18.5] mm².

22. Power estimates

Processor

ARM968 (from ARM web site) consumes 0.12 to 0.23 mW/MHz on a 130 nm process, and delivers 1.1 dhrystone MIPS/MHz. Thus, to a good approximation, its power-efficiency is 5,000 to 10,000 MIPS/W and it uses 100-200 pJ/instruction.

neuron dynamics

30 instructions at 1 kHz = 30 kIPS = 3-6 μ W.

connection processing

1,000 inputs at 10 Hz (ave.) and 10 instructions/input = 100 kIPS = 10-20 μ W.

SDRAM access

assume SDRAM uses 250mW at 1 Gbyte/s; accessing 4 bytes costs 1 nJ.

1,000 inputs at 10 Hz (ave.) = 40 kByte/s = 10 μ W.

communications link

1.8 V I/Os, 10 pF/wire = 15 pJ/transition

3 transitions/4 bits + EOP = 33 transitions/spike = 0.5 nJ/spike/link.

Router

assume power budget at full throughput of 200 MHz is 200 mW, so 1 nJ/route.

neuron total

at 10 Hz (ave.), with H hops, power = 3-6 + 10-20 + 10 + (1 + 1.5H) 10^{-3} μ W
= 23-36 μ W (routing & inter-chip hops are negligible).

Chip

20 processors x 1,000 neurons/processor x 13-26 μ W = 260-520 mW.

Node

chip + SDRAM = 460-720 mW.

System

1 billion neurons = 50,000 nodes = 23-36 kW.

23. To Do...

Check DMA controller section

- update to match post-review design

Comms controller

- Rx buffer size?
- NN packet type should be '1x'?

Interchip interfaces

- revise to reflect 3-of-6 CHAIN protocol
- include Yebin's fault tolerance aspects?

Router

- time phase register format
- details to be checked/updated following Router Review

System Controller

- several details to be completed

Fault-tolerance and test features

- still quite a lot to be detailed.

Does the ARM968 JTAG require the Comms Rx & Tx interrupts?

...and quite a lot more!

S p i N N a k e r